

Operating and Installation Instructions Combi Steam Oven



To prevent accidents and machine damage, read these instructions **before** installation or use.

Contents

IMPORTANT SAFETY INSTRUCTIONS	8
Overview	18
Front view	18
Included accessories	20
Control panel	21
Sensor buttons	22
M Touch display	23
Symbols	24
Operation	25
Description of functions	27
Control panel	27
Water container	27
Grease filter	27
Roast probe	27
Temperature / Core temperature	27
Moisture content	28
Cooking duration	28
Noises	28
Preheating phase	29
Cooking phase	29
Steam reduction	29
Oven interior lighting	29
Before using for the first time	30
General settings	30
Cleaning for the first time	31
Setting the water hardness level	32
Setting the correct boiling point for water	33
Heating up the steam oven	33
Modes / Programs / Menus	34
Operation: Steam cooking	37
Quick guide	37
Interrupting operation	39
Additional functions	40
Turning on and off automatically	40
Sequence of an automatic cooking process	41
Changing settings during a cooking process	41
Canceling cooking	42

Operation: Combination cooking mode	43
Quick guide	44
Interrupting operation	46
Additional functions.....	47
Turning on and off automatically	47
Sequence of an automatic cooking process.....	48
Changing settings during a cooking process.....	48
Canceling cooking.....	49
Operation: Functions without steam	50
Quick guide	51
Interrupting operation	52
Additional functions.....	53
Turning off automatically	54
Turning on and off automatically	54
Sequence of an automatic cooking process.....	55
Rapid PreHeat	55
Changing the operating mode.....	56
Changing settings during a cooking process.....	56
Canceling cooking.....	57
MyMiele	58
To add an entry.....	58
Editing MyMiele	59
Deleting entries.....	59
Sorting entries	59
MasterChef	60
List of automatic programs	60
Using the MasterChef programs	61
Search	62
Favorites	63
Creating a Favorite	63
Starting a Favorite	64
Changing Favorites.....	65
Changing cooking stages.....	65
Changing the name	65
Deleting a Favorite.....	66
Alarm + Timer	67
Using the alarm 	67
Setting the alarm	67
Changing an alarm	67

Contents

Deleting an alarm	67
Using the Timer 	68
Setting the timer	68
Resetting the timer	68
Canceling the timer	68
General notes	69
The advantages of cooking with steam	69
Suitable containers	69
Cooking pans	69
Using your own cookware	69
Shelf level	70
Frozen food	70
Temperature	70
Cooking duration	70
Cooking with liquid	70
Your own recipes - Steam cooking	70
Wire oven rack / universal tray	71
Steam cooking	72
Vegetables	72
Meat	75
Sausage	77
Fish	77
Shellfish	80
Mussels	81
Rice	82
Pasta	83
Dumplings	84
Grains	85
Legumes	86
Eggs	88
Fruit	89
Menu Cooking - Manual	90
Sous-vide (vacuum) cooking	92
Reheating	98
Special modes	100
Reheat	100
Defrost	102
Canning	105
Juicing	106
Menu Cooking	107

Contents

Dehydrate	108
Making Yogurt	109
Proofing	110
Dissolving Gelatine.....	111
Melting Chocolate	111
Skinning Fruits and Vegetables	112
Preserving Apples	113
Blanching.....	113
Sweating Onions	114
Rendering Fat	114
Sanitizing Cookware	115
Heating damp towels	115
Decrystalize honey	116
Pizza	116
Making jam.....	117
Sabbath Program	118
Roast probe	119
Roast	122
Bake.....	129
Broil.....	136
Settings	139
Accessing the "Settings" menu.....	139
Changing and saving settings	139
Settings overview	140
Language 	142
Time of day.....	142
Display.....	142
Display.....	142
Clock format.....	142
Setting the time	142
Synchronize.....	142
Date	143
Lighting.....	143
Start screen	143
Brightness	143
Volume.....	143
Buzzer tones.....	143
Keypad tone	143
Welcome melody.....	143

Contents

Units of measurement	144
Weight	144
Temperature	144
Keeping Warm	144
Automatic rinsing	145
Steam reduction	145
Recommended temperatures	145
Safety	145
System lock 	145
Sensor lock	146
Water hardness	146
Showroom program	147
Demo mode	147
Factory default settings	147
Cleaning and care	148
Important information on cleaning and care	148
Appliance front	149
PerfectClean	150
Oven interior	151
Water container	153
Accessories	153
Shelf runners	154
Maintenance	155
Soak	155
Drying	155
Rinsing	155
Descaling	155
Door	157
Frequently asked questions	159
Optional accessories	165
Cooking pan	165
Cleaning and care products	167
Additional accessories	168
IMPORTANT SAFETY INSTRUCTIONS - INSTALLATION	170
Detailed dimensions of oven front	171
Connecting the water intake and drain hoses	173
Installation dimensions	174
Installation into a tall cabinet	174

Contents

Undercounter installation	176
Installation in combination with an oven	178
Installation and connection	180
Water connection	181
Connection to the water supply	181
Connecting the water supply	182
Connection to the drainage system	183
Connecting the drain hose	183
Electrical connection	184
Power Supply	184
Caring for the environment	185
Technical service, data plate, warranty	186
MieleCare	187
Copyright and licenses	188

IMPORTANT SAFETY INSTRUCTIONS

The Combi Steam oven is referred to in the following instructions as steam oven.

This appliance conforms to current safety requirements. Inappropriate use can, however, lead to personal injury and damage to property.

To avoid the risk of accidents and damage to the appliance, please read these instructions carefully before installing or using it for the first time. They contain important notes on installation, safety, use and maintenance.

Keep these instructions in a safe place and pass them on to any future owner.

SAVE THESE INSTRUCTIONS

IMPORTANT SAFETY INSTRUCTIONS

Use

- ▶ This appliance is intended for residential use only.
- ▶ The steam oven is not suitable for outdoor use.
- ▶ This steam oven is intended for domestic use only as described in these operating instructions.
Any other usage is not supported by the manufacturer and could be dangerous.
- ▶ Persons who lack physical, sensory or mental abilities, or experience with the appliance should not use it without supervision or instruction by a responsible person.
- ▶ This steam oven is supplied with a special bulb to cope with particular conditions (e.g. temperature, moisture, chemical resistance, abrasion resistance and vibration). This special bulb must only be used for the purpose for which it is intended. It is not suitable for room lighting. Replacement of bulbs may only be carried out by a Miele authorized technician.

IMPORTANT SAFETY INSTRUCTIONS

Children

- ▶ Activate the system lock to ensure that children cannot switch on the steam oven inadvertently.
- ▶ Children must not be allowed to clean the steam oven unsupervised.
- ▶ Please supervise children in the vicinity of the steam oven and do not let them play with it.
- ▶ As with any other appliance, you must constantly keep an eye on children while the steam oven is in operation.
- ▶ Danger of suffocation! Ensure that any plastic wrappings, bags, etc. are disposed of safely and kept out of the reach of children.
- ▶ Danger of burning. Children's skin is far more sensitive to high temperatures than that of adults. The door, control panel and the ventilation cut-outs for oven compartment ventilation all get hot. Make sure that children do not touch the steam oven or attempt to open the door when it is in operation. Keep children well away from the appliance until it has cooled down and there is no danger of burning.
- ▶ Risk of injury! The maximum allowable weight on the door is 22 lbs (10 kg).
Do not allow children to hang, lean or sit on the door when open.

IMPORTANT SAFETY INSTRUCTIONS

Technical safety

- ▶ Installation, repair and maintenance work should be performed by a Miele authorized service technician in accordance with national and local safety regulations and the provided installation instructions. Contact Miele's Technical Service Department for examination, repair or adjustment. Repairs and other work by unauthorized persons could be dangerous and may void the warranty.
- ▶ A damaged appliance is dangerous. Check the appliance for any visible damage. Never install or attempt to use a damaged appliance.
- ▶ Reliable and safe operation of this steam oven can only be assured if it has been connected to the power supply.
- ▶ Be certain your appliance is properly installed and grounded by a qualified technician. To guarantee the electrical safety of this appliance, continuity must exist between the appliance and an effective grounding system. It is imperative that this basic safety requirement be met. If there is any doubt, have the electrical system of the house checked by a qualified electrician.
- ▶ Before connecting the appliance to the power supply, ensure that the connection data on the data plate (voltage and frequency) match the power supply.
This data must correspond in order to avoid the risk of damage to the appliance. Consult a qualified electrician if in any doubt.
- ▶ Do not use an extension cord to connect this appliance to the power supply. Extension cords do not guarantee the required safety of the appliance.
- ▶ For safety reasons, this appliance may only be used after it has been built in.
- ▶ This steam oven must not be used in a non-stationary location (e.g. on a ship).

IMPORTANT SAFETY INSTRUCTIONS

- ▶ Tampering with electrical connections or components and mechanical parts is highly dangerous to the user and can cause operational faults. Do not open the outer casing of the appliance.
- ▶ While the appliance is under warranty, repairs should only be performed by a Miele-authorized service technicians. Work by unqualified persons could be dangerous and may void the warranty.
- ▶ Defective components should be replaced by Miele original parts only. Only with these parts can the manufacturer guarantee the safety of the appliance.
- ▶ If the plug has been removed or the power cord is not supplied with a plug, the steam oven must be connected to the power supply by a suitably qualified electrician.
- ▶ If the power cord is damaged, it must be replaced with a special connection cable type H 05 VV-F (PVC insulated). See "Electrical connection."
- ▶ Before installation, maintenance, and repair work, the steam oven must be disconnected from the electrical supply. It is only completely isolated from the electrical supply if: the fuse has been removed (where applicable), the main circuit breaker has been tripped, or the power cord has been unplugged from the wall outlet. Always be sure to pull the plug not the cord.
- ▶ During installation, maintenance and repair work, the appliance must be disconnected from the main electricity supply. It is only completely isolated from the electricity supply when:
 - The circuit breakers have been switched off, or
 - The fuses of the electrical installation have been completely removed, or
 - Unplug (if plug present) the machine from the outlet. Pull the plug not the cord.

IMPORTANT SAFETY INSTRUCTIONS



- ▶ If the steam oven is installed behind a cabinet door, do not close the door while the appliance is in operation. Heat and moisture can build up behind the closed door and cause damage to the range and to the surrounding cabinets and flooring. Do not close the door until the appliance has completely cooled down.
- ▶ This steam oven must be plumbed in by a suitably qualified person.
Miele cannot be held liable for damage caused by incorrect installation or connection.
- ▶ The appliance must be connected to the cold water supply only.
- ▶ The faucet must be easily accessible after the appliance has been installed.
- ▶ Before connection, check the intake and drain hoses for visible signs of damage.
- ▶ The built-in water protection system will only protect the appliance from water damage if the following conditions have been met:
 - The intake and drain hoses are correctly fitted and connected.
 - The steam oven is properly maintained and parts are replaced where it can be seen that this is necessary.
 - The water tap has been turned off during longer absences (for example, vacation).
- ▶ Do not repair or replace any part of the appliance unless specifically recommended in the manual. All other servicing should be referred to a qualified technician.
- ▶ Do not operate any appliance with a damaged cord or plug, or if the appliance has been damaged in any manner. Contact Miele's Technical Service Department.

IMPORTANT SAFETY INSTRUCTIONS

Proper use

- ▶ Danger of burning. The steam oven becomes hot when in use. You could burn yourself on the heating elements, oven interior, cooked food, oven accessories or hot steam. Use pot holders when placing food in the oven or removing it and when adjusting oven shelves etc. in a hot oven. Take care when putting cooking pans into the oven or removing them not to spill the contents.
- ▶ Use only dry, heat-resistant potholders. Moist or damp potholders used on hot surfaces may result in steam burns. Do not let potholders come in contact with oil or grease. Do not substitute dish towels or other bulky items for potholders. Do not let potholders touch hot heating elements.
- ▶ Do not heat up food in closed containers e.g. tins or sealed jars in the steam oven, as pressure will build up in the container, causing it to explode.
- ▶ Plastic containers which are not suitable for use in an oven can melt at high temperatures and can even damage the steam oven or catch fire.
Only use plastic containers which are declared by the manufacturer as being suitable for use in a steam oven. Follow the manufacturer's instructions on use. If you want to use plastic containers for steaming food make sure that they are temperature resistant to 210°F / 100°C and steam resistant. Any other plastic containers could melt, become brittle or break when subjected to heat.
- ▶ Food which is left in the oven to be kept hot can dry out and the moisture released can lead to corrosion damage in the appliance. Do not use the steam oven for keeping food warm and do not use utensils in the appliance which could corrode.
- ▶ Do not leave the appliance door open unnecessarily as someone may trip over it or be injured by it.

IMPORTANT SAFETY INSTRUCTIONS

- ▶ The door can support a maximum weight of 22 lbs (10 kg). Do not sit, lean or place heavy items on the open oven door. Also be sure nothing can get trapped between the door and the oven cavity. The steam oven could get damaged.
- ▶ Oil and fat can ignite if overheated. Never leave the steam oven unattended when cooking with oil and fat.
If it does ignite do not put the flames out with water. Switch the steam oven off immediately and then suffocate the flames by keeping the oven door closed.
- ▶ Smother the fire or flames, or use a dry chemical extinguishing agent or foam fire extinguisher.
- ▶ Due to the high temperatures radiated, objects left near the steam oven when it is in use could catch fire.
Do not use the steam oven to heat up the room.
- ▶ Broiling food for an excessively long time can cause it to dry out with the risk of catching fire.
Do not exceed recommended broiling times.
- ▶ Some foods dry out very quickly and can be ignited by high broiling temperatures. Do not use broiling functions for crisping rolls or bread or to dry flowers or herbs. Instead use the Convection Plus  or Surround  functions.
- ▶ To avoid fueling any flames, do not open the appliance door if you see smoke coming from the food in the oven interior. Interrupt the current process by turning off the appliance and disconnecting it from the power. Do not open the door until the smoke has dissipated.
- ▶ Use caution when using alcohol in your recipes. Alcohol evaporates at high temperatures but may, in rare circumstances, combust on the hot heating elements.
- ▶ Never cover the floor of the oven with aluminum foil, or place oven dishes, pans, saucepans or trays directly onto the floor of the oven.

IMPORTANT SAFETY INSTRUCTIONS

- ▶ Never use the steam oven without a drain filter as large food residues may block the drain and the pump.
- ▶ When using an electrical appliance, e.g., a hand-held mixer, near the steam oven, make sure that the power cord does not get caught in the door. The insulation on the cord could become damaged, giving rise to an electric shock hazard.
- ▶ Do not operate the appliance without the lamp cover. Steam could attack the electrical components and cause a short circuit. Steam could also damage the electrical components.
- ▶ The steam oven should be installed at a safe height for users to safely access all cooking levels and pans. Otherwise spills could cause burns or scalding and children may be put at risk by the hot appliance door.
- ▶ Flammable materials should not be stored in an oven or in the vicinity of the cooktop.
- ▶ Open the door carefully to allow hot air or steam to escape before placing or removing food.
- ▶ Keep the oven vent ducts open.
- ▶ Wear proper apparel - Loose-fitting or hanging garments should never be worn while using the appliance.
- ▶ To prevent burns, always place oven racks at their desired height while the steam oven is cool. If the rack must be moved while the oven is hot, do not let pot holders touch hot heating elements.
- ▶ Caution: Heating elements may be hot even though they are not glowing. Interior surfaces of an steam oven become hot enough to cause burns. External parts of the steam oven such as the door glass, vents, and the control panel can become hot. During and after use, do not touch, or let clothing or other flammable materials come into contact with heating elements or interior surfaces of the steam oven until they have had sufficient time to cool.

IMPORTANT SAFETY INSTRUCTIONS

Cleaning and care

- ▶ Do not use a steam cleaner to clean this oven. Steam could penetrate electrical components and cause a short circuit.
- ▶ Scratches on the door glass can cause the glass to break. Do not use abrasive cleaners, hard sponges, brushes or sharp metal tools to clean the door glass.
- ▶ To avoid corrosion on the stainless steel surfaces of the Speed Oven, remove any splashes on the interior walls of the oven from food or liquids containing salt.

Accessories

- ▶ Use only genuine original Miele parts. If parts or accessories from other manufacturers are used, the warranty will become void.
- ▶ Only use the Miele roast probe supplied with this oven. If it is faulty, it must only be replaced with a Miele genuine roast probe.
- ▶ The plastic on the roast probe can melt at very high temperatures. Do not use the roast probe when using the broil functions (exception: Convection Broil ). Do not store the roast probe in the oven if it is not in use.
- ▶ The perforated and solid cooking pans will be damaged by high temperatures! Use them only in modes and programs that work exclusively with steam.

Overview

Front view

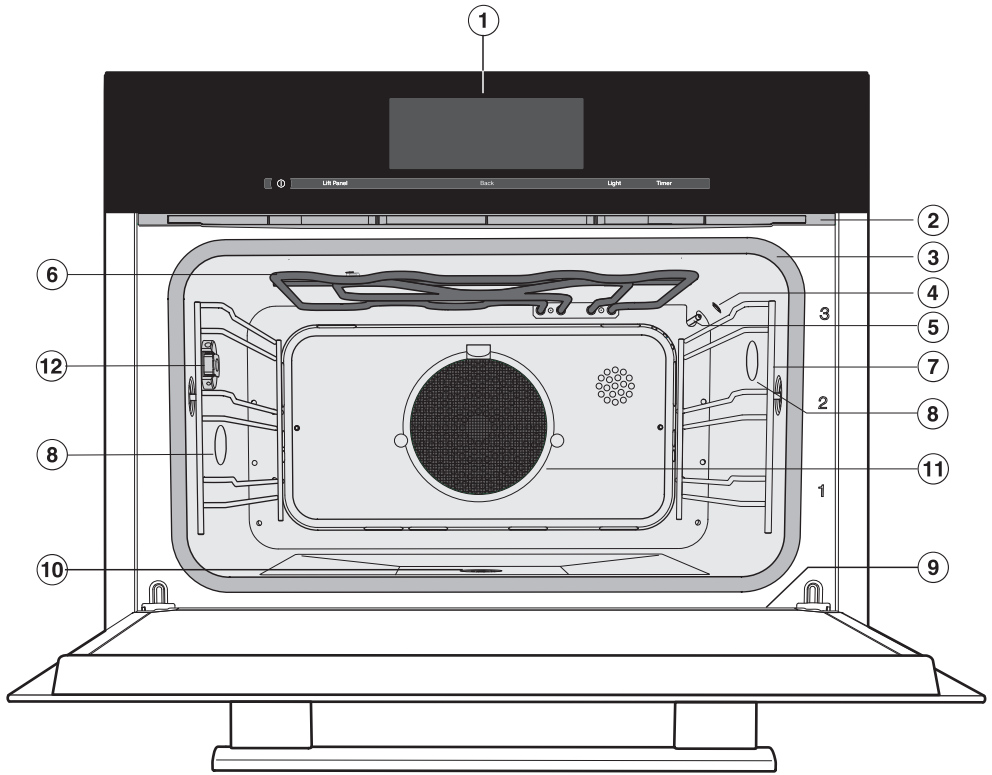

- ① Control panel
- ② Vent
- ③ Door gasket
- ④ Moisture sensor
- ⑤ Temperature sensor
- ⑥ Browning / Broiling element
- ⑦ Side runners with 3 shelf levels
- ⑧ Oven interior lighting
- ⑨ Drip channel
- ⑩ Drain
- ⑪ Grease filter
- ⑫ Connection socket for the roast probe

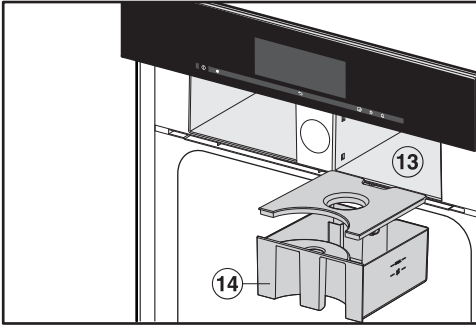

⑬ Slide-in compartment for water container

⑭ Water container

Overview

Included accessories

The accessories supplied with your appliance, as well as a range of optional ones, are available to order from Miele (see "Optional accessories").

The perforated and solid cooking pans will be damaged by high temperatures!

Use them only in modes and programs that work exclusively with steam.

DGG 20

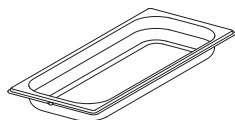

1 solid cooking pan
17 11/16" x 7 1/2" x 1 9/16" (WxDxH)
450 x 190 x 40 mm (WxDxH)

DGGL 20

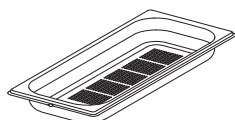

1 perforated cooking pan
17 11/16" x 7 1/2" x 1 9/16" (WxDxH)
450 x 190 x 40 mm (WxDxH)

DGGL 12

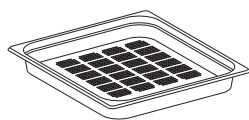

1 perforated cooking pan
17 11/16" x 15 3/8" x 1 9/16" (WxDxH)
450 x 390 x 40 mm (WxDxH)

Universal tray

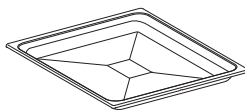

1 universal tray for baking, roasting and broiling

Wire oven rack



1 wire oven rack for baking, roasting and broiling

Roast probe

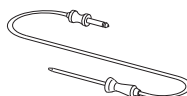

1 roast probe for precise temperature controlled cooking, which monitors the internal temperature of the meat (core temperature).

FlexiClip telescopic runners HFC 71

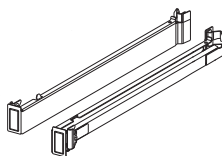

1 pair of FlexiClip telescopic runners
The FlexiClip telescopic runners can be clipped into any of the existing shelf runners and pulled out of the oven to their fullest extent.

FlexiClip runners are supplied with their own instructions on how to install and look after them.

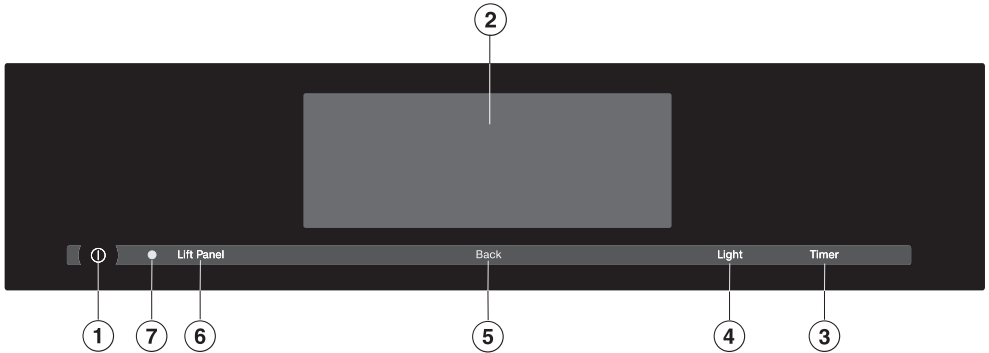



- ① Recessed On / Off ① button
To turn the appliance on and off
- ② Display
Shows the time of day and user information in addition to selection of applications and setting various parameters
- ③ "Timer" sensor button
For setting the timer and/or alarm
- ④ "Light" sensor button
To turn the oven interior lighting on and off
- ⑤ "Back" sensor button
To go back one step at a time
- ⑥ "Lift Panel" sensor button
For opening/closing the control panel
- ⑦ Optical interface
(for service technician use only)

Control panel

Sensor buttons

The sensors react to touch. Each touch is confirmed with an audible tone. This tone can be turned off (see "Settings – Volume - Keypad tone").

Sensor button	Function	Notes
Back	To go back a step	
Lift Panel	For opening/closing the control panel	
	For switching the oven interior lighting on and off	<p>If a menu appears in the display or if a cooking process is running, touching  will switch the interior light on or off.</p> <p>If the display is dark, this sensor will not react until the steam oven is switched on.</p> <p>The oven interior lighting switches off after 15 seconds during cooking or remains on continuously, depending on the setting selected.</p>
	For activating and deactivating timer / alarm	<p>If a list of options is shown in the display, or if a cooking process is running, you can enter a timer duration (e.g. when boiling eggs) or an alarm time, i.e. a specific time, at any point (see "Alarm + timer").</p> <p>If the display is dark, this sensor will not react until the steam oven is switched on.</p>

M Touch display

Make sure that water cannot get behind the touch display.

The touch display can be scratched by pointed or sharp objects, e.g. pens and pencils.

Only touch the display with your fingers.

Touching the display with your finger emits a small electrical charge which in turn triggers an electrical pulse that is detected by the surface of the Touch display.

The touch display is organized into three areas.

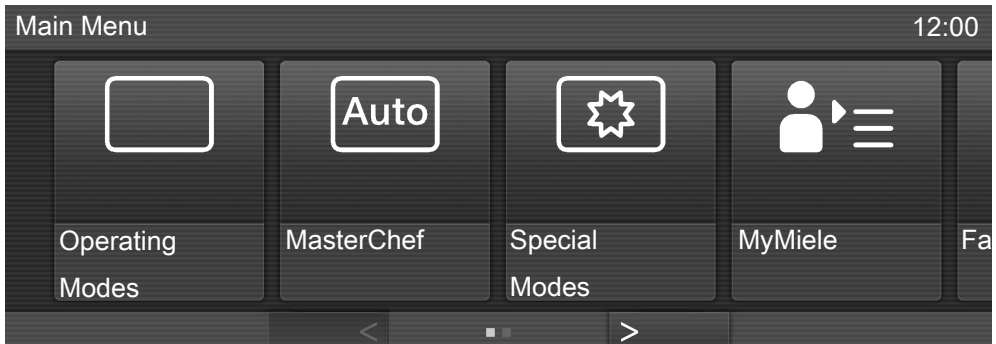

The top line shows you where you are in a menu. If you are in a submenu, you can return to the previous menu level by tapping on the desired menu name or on the boxes. The time of day, alarm, and timer appear in the top right-hand corner of the display.







The middle section shows the current menu and menu items. You can scroll to the right or left by swiping your finger across the display.

The < and > arrows at the bottom of the screen are used for scrolling to the left or right. The number of small squares between the arrows indicates the number of pages available and your position within the current menu.

Control panel

Symbols

The following symbols may appear in the display:

Symbol	Description
	Some settings, e.g. display brightness and buzzer volume, are selected using a bar chart.
	This symbol indicates that there is additional information and advice about using the oven. Select <i>OK</i> to access the information.
	The system lock or sensor lock is active (see "Settings - Safety"). The oven cannot be used.
	Alarm
	Timer
	This indicates that there are more options available, which are not visible because there is not enough space in the display.
	Core temperature when using the roast probe

Operation

Whenever you touch a possible option the relevant field will light up orange.

To select or open a menu

- Touch the desired field to select it.

Scrolling

You can scroll left or right.

- Swipe the screen, i.e., place your finger on the touch display and move it in the desired direction.
- Or: touch the < and > arrows with your finger to scroll left or right.

Exiting a menu

- Touch ↵, select an option in the menu path at the top of the screen, or touch ...

Depending on the current menu, this will take you back one level or return you to the Main Menu.

Help function

With some functions and options Help appears.

- Select the function.

Helpful information will then appear in text and pictures.

Control panel

Entering numbers

You can enter numbers by scrolling through and touching the roller, or by using the numeric keypad.

To enter numbers using the roller:

- Swipe the roller up or down to select the desired number.

To enter numbers using the numeric keypad:

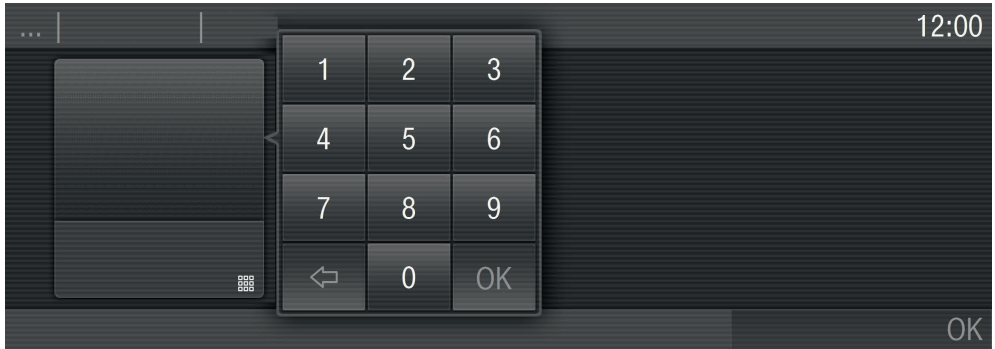

- Touch  in the bottom right of the input field.

The numeric keypad appears.

- Touch the required numbers.

As soon as you enter a valid value, the *OK* field changes to green. Use the arrow to delete the most recent entry.

- Touch *OK*.

Entering letters

Enter a name using a keyboard. Try to use short, concise names.

- Select the required letters or characters.
- Touch *Save*.

Control panel

The water container is located behind the control panel. You open and close the control panel by touching the  sensor. The panel features jamming protection. If the control panel encounters resistance during opening/closing, the process is interrupted. Nevertheless, do not touch the handle on the door during opening and closing!

Water container

Water is pumped into the water container and then into the steam generator.

A fault can occur if the opening to the water container is blocked.

The opening on the front of the water container must not be blocked as otherwise water cannot be pumped into the steam generator.

Grease filter

Insert the grease filter in the back wall for all roasting programs.

It should be removed when using steam programs.

It must also be removed when baking, as otherwise results can be uneven (exception: deep fresh fruit pies, pizza with extra toppings).

Roast probe

The roast probe measures the core temperature in the food, enabling the temperature during the cooking process to be monitored simply and accurately.

Temperature / Core temperature

Some modes offer a recommended temperature. The recommended temperature can be changed for a single cooking program or cooking step, or permanently within a specific area (see "Settings – Recommended temperatures").

It is also possible to change the core temperature for a single cooking program or cooking step within the specified area.

Description of functions

Moisture content

The Combi Steam  and Reheat modes use a combination of oven heat and moisture. You can alter the moisture level within a given range for an individual cooking program or a cooking stage.

Depending on the setting for the program, either moisture or fresh air is injected into the oven. If the humidity level is set to 0%, the maximum amount of air will be injected and no moisture. If the level is set to 100%, air will not be injected into the oven and the maximum amount of moisture will be injected.

Some food gives off moisture during the cooking process. This moisture from the food also controls the amount of moisture needed. If the required amount of moisture is very low and the food already contains a lot of water the steam generator may not be activated at all.

Cooking duration

Depending on the function, you can set a cooking duration of between 1 minute and 6, 10 or 12 hours.

The duration of the MasterChef, Maintenance and Menu Cooking programs is set at the factory and cannot be altered.

With the Steam Cooking  mode and programs that use steam alone, the cooking duration does not start to count down until the set temperature has been reached. It begins immediately with all other modes and programs.

Noises

You will hear a pumping sound when the appliance is turned on, during use and after turning it off. This is the sound of water being pumped through the system and is quite normal.

When the steam oven is in use, you will hear a fan noise.

Preheating phase

During the preheating phase the display will show the temperature in the cooking compartment as it rises and Preheating in all programs except for MasterChef, Menu Cooking, and Maintenance.

During steam cooking, the duration of the preheating phase will depend on the quantity and the temperature of the food. In general this phase will last for approx. 5 minutes. The duration will be longer if you are preparing refrigerated or frozen food.

Cooking phase

The cooking phase begins when the set temperature is reached. During the cooking phase, the time left will be shown on the display.

Steam reduction

If cooking is performed in a certain temperature range during steam cooking and combination cooking, the steam reduction function switches on automatically at the end of the cooking program. This reduces the amount of steam which escapes from the appliance when the door is opened at the end of the cooking duration. Steam Reduction will appear in the display in addition to Program Finished.

This function can be switched off if you wish (see "Settings - Steam reduction").

Oven interior lighting

The oven light has been set at the factory to go out when cooking starts.

If you want it to stay on all the time the oven is on you will need to alter the default setting (see "Settings - Lighting").

If the door is left open at the end of a cooking program, the oven lighting will turn off automatically after 5 minutes.

The oven lighting gives off heat. If you are operating the combi steam oven at a temperature below 125°F (50°C), the oven compartment lighting switches off automatically.

If the "Light" button on the control panel is pressed, the oven compartment lighting will come on for 15 seconds.

Before using for the first time

General settings

 The steam oven must not be operated until it has been correctly installed.

The steam oven will turn on automatically when it is connected to the power supply.

Welcome screen

A welcome screen is displayed. You will then be asked to select some basic settings which are needed before the appliance can be used.

- Follow the instructions on the display.

Set the language

- Select the desired language.
- Confirm with OK.

Set the country

- Select the desired country.
- Confirm with OK.

Set the date

You can enter numbers by scrolling through and touching the roller, or by using the numeric keypad.

- Set the day, month and year.
- Confirm with OK.

Setting the clock

You can enter numbers by scrolling through and touching the roller, or by using the numeric keypad.

- Set the time of day in hours and minutes.
- Confirm with OK.

The time of day can be displayed in 12-hour format (see "Settings - Time of Day - Clock Format").

Before using for the first time

Time of day format

You will then be asked when you want the time of day to show on the display when the steam oven is turned off (see "Settings - Time of Day - Display"):

– On

The time is always visible on the display.

– Off

The display appears dark to save energy. Some modes are limited.

– Night Dimming

The time only shows on the display between 5:00 am and 11:00 pm. It turns off at night to save energy.

■ Select the desired option.

■ Confirm with OK.

Information regarding energy consumption will appear on the display.

■ Confirm with OK.

Set-up Successfully Completed is displayed.

■ Confirm with OK.

The steam oven is ready for use.

If you accidentally select the wrong language, follow the instructions described in "Settings - Language 🗑️."

■ Please stick the extra data plate for the appliance supplied with this documentation in the space provided in the "After sales service, data plate, warranty" section of this manual.

■ Remove any protective foil and stickers.

The appliance has undergone a function test in the factory. Residual water from this testing may have dripped from the lines into the oven cavity during transportation.

Cleaning for the first time

Water container

 Danger!

Do not touch the door handle when opening the control panel. Your fingers could be pinched.

■ Tap "Lift Panel" to open the control panel.

■ Remove the water container by pushing upwards slightly as you take it out of the appliance.

■ Wash the water container by hand using a soft clean sponge and a mild solution of warm water and liquid dish soap or in the dishwasher.

Before using for the first time

Accessories / Oven interior

- Remove all accessories from the steam oven.
- Wash them by hand using hot water and a soft clean sponge and a mild solution of warm water and liquid dish soap or in the dishwasher.

Risk of damage to the surfaces of the universal tray and the wire oven rack.

The universal tray and wire oven rack are treated with PerfectClean and must **only** be cleaned by hand. See "Cleaning and care - Perfect-Clean" for more information.

- Clean the universal tray and wire oven rack with a solution of warm water and liquid dish soap applied with a soft sponge.

The interior of the steam oven has been treated at the factory with a conditioning agent.

- To remove this, clean the oven interior with warm water and liquid dish soap and then dry thoroughly with a soft cloth.

Setting the water hardness level

The steam oven is factory set for Hard water. It must be adjusted local water hardness to ensure trouble-free operation and to ensure that descaling is carried out at the correct interval. The harder the water, the more often it will need to be descaled.

- Check the hardness of your local water supply and adjust the water hardness as necessary (see "Settings - Water hardness").

Setting the correct boiling point for water

Before cooking food for the first time, you must set the boiling point for water, as this varies depending on the altitude of the installation location of the appliance. This procedure also flushes out the waterways.

This procedure **must** be carried out to ensure efficient functioning of your appliance.

- You should then run the Steam Cooking  program at 210°F / 100°C for 15 minutes. Proceed as described in "Operation – Steam cooking."

Resetting the correct boiling point for water

If you move, the appliance will need to be re-set for the new altitude if this differs from the old one by 984 ft (300 m) or more. To do this, descale the appliance (see "Cleaning and care – Maintenance – Descaling").











Heating up the steam oven

- To remove the grease from the ring heating element, heat the appliance up with nothing in it at 400°F / 200°C using the Convection Bake  function for 30 minutes. Proceed as described in "Operation – Functions without steam."







There will be a slight smell the first time the heating element is heated up. The smell and any vapors will dissipate after a short time, and do not indicate a faulty connection or appliance.

It is important to ensure that the kitchen is well ventilated during this operation.







Modes / Programs / Menus

	Default temperature/ Setting	Temperature range
Operating Modes <input type="checkbox"/>		
Convection Bake  For baking on several levels at the same time. The fan distributes the heat evenly throughout the cavity for a consistent baking temperature.	320°F / 160°C	85-435°F / 30-225°C
Surround  Heat is used from both the upper and lower heating elements to create perfect results of all baking recipes.	350°F / 180°C	85-435°F / 30-225°C
Combi Steam  For baking, roasting and broiling. For more information see "Operation: Combination cooking mode", "Roast", "Bake"		
Convection Bake 	340°F / 170°C	85-435°F / 30-225°C
Surround 	350°F / 180°C	85-435°F / 30-225°C
Maxi Broil 	Level 3	Levels 1-3
Steam Cooking  Retains the flavor and nutrients of the food without added fats or oils.	210°F / 100°C	105-210°F / 40-100°C
Sous-vide  Cooking food in a vacuum bag	150°F / 65°C	115-195°F / 45-90°C
Intensive  This mode gently circulates heated air from the lower heating element using the fan to create a brick oven environment.	350°F / 180°C	120-435°F / 50-225°C
Bake  Use this at the end of the baking time to brown the bottom of the food.	375°F / 190°C	210-435°F / 100-225°C
Browning  For a perfectly browned topping, for example when making a gratin or browning the top of a casserole.	375°F / 190°C	210-435°F / 100-225°C

Modes / Programs / Menus

	Default temperature/ Setting	Temperature range
Operating Modes <input type="checkbox"/>		
Maxi Broil  The entire upper heating element is used for intense heating from above. Excellent browning and searing results can be achieved.	Level 3	Level 1-3
Broil  For broiling smaller quantities of steak, chops, kebabs, etc.	Level 3	Level 1-3
Convection Broil  This mode distributes hot air from the Browning/Broiling element over the food using the fan.	400°F / 200°C	120-435°F / 50-225°C
Humidity Plus  A special baking program for light pastries, cakes and baked goods.	320°F / 160°C	85-435°F / 30-225°C
Gentle Bake  For cooking sweet and succulent bakes and gratins	320°F / 160°C	85-435°F / 30-225°C
MasterChef <input type="checkbox"/> Auto		
The list of available MasterChef programs is displayed.		
Special Modes <input type="checkbox"/> 		
Menu Cooking Simultaneous cooking of various foods	–	–
Pizza	350°F / 180°C	350-435°F / 180-225°C
Defrost For gentle thawing of frozen foods	140°F / 60°C	120-140°F / 50-60°C
Reheat To gently reheat already cooked foods	265°F / 130°C	248-284°F / 120-140°C
Blanch	–	–

Modes / Programs / Menus

	Default temperature/ Setting	Temperature range
Special Modes 		
Canning	195°F / 90°C	175-210°F / 80-100°C
Sanitize Cookware	–	–
Dehydrate	140°F / 60°C	140-160°F / 60-70 °C
Proof	–	–
Sabbath Program	350°F / 180°C	85-435°F / 30-225°C
MyMiele  		
You can personalize your steam oven with MyMiele by entering frequently used applications.		
Favorites 		
Create and save your favorite dishes		
Settings 		
Changing the factory default settings		
Maintenance 		
Descale	–	–
Soak	–	–
Drying	–	–
Rinse	–	–

Operation: Steam cooking

A fault can occur if the drain is blocked.

Check that the drain filter is correctly in place before each program as large food residues can clog the drain.

Quick guide

- Turn the steam oven on ①.

The main menu appears on the display.

- Put the food in the oven.
- Select Operating Modes .
- Select Steam Cooking .

The following will appear on the display:

- Temperature
- Duration
- Adjust the recommended temperature if necessary.
- Set the cooking duration. Any time between 1 minute and 10 hours can be set.

After the cooking duration has been set, the following also appears in the display

- Ready at
- Start at
- Additional Settings (see "Additional functions - Changing the mode").

- Set further settings as necessary (see "Additional functions")

- Confirm with OK.

The cooking process begins. The steam condenser, lighting, and fan turn on.

Operation: Steam cooking

At the end of the cooking duration

- Steam Reduction (with temperatures over approx. 175°F / 80°C) and Program Finished will appear in the display,
- The fan remains on.
- A buzzer will sound if turned on (see "Settings - Volume - Buzzer tones").

You have the option to save the program as a Favorite (see "Favorites") or to increase the cooking duration using Change. Tap "Back" to go back to the main menu.

Burn hazard!

You could burn yourself on the oven interior walls, spilled food and accessories

Use pot holders when removing hot food from the oven.

- Wait until Steam Reduction goes out on the display before opening the door and removing the food.

After use

- Remove the water container by pushing upwards slightly as you take it out of the appliance and empty it.
- Switch the steam oven off .

Following a cooking program with steam, Appliance Rinsing will appear in the display after the steam oven has been switched off.

This process should be carried out every time to flush any remaining food deposits out of the system.

- Follow the instructions in the display.
- After each use, clean and dry the whole appliance as described in "Cleaning and care."
- Leave the appliance door open until the oven compartment is completely dry.

Interrupting operation

Operation is interrupted as soon as the door is opened. The heating will be turned off and the cooking duration remaining stored in memory.



Burn hazard!

Steam can escape when the door is opened.

Step back and wait until the steam has dissipated.



Burn hazard!

You could burn yourself on the oven interior walls, spilled food and hot steam.

Use pot holders when inserting, removing or turning hot food, or when adjusting shelves, etc. in a hot oven.

Operation will resume when the door is closed.

The oven will heat up again and the display will show the temperature of the cooking compartment as it rises.

Once the set temperature has been reached, the display will change to show the cooking duration remaining as it counts down.

The cooking process will be ended early if the door is opened during the last minute of cooking (55 seconds standing time).

Operation: Steam cooking

Additional functions

Setting additional durations

You have placed the food in the oven, selected a temperature and a duration.

You can set the program to turn off or on and off automatically by entering Ready at or Start at.

– Ready at

You specify the time you want cooking to stop.

– Start at

You specify the time you want cooking to start.

Cooking results can be impaired if there is a long delay between the food being placed in the oven and the start of cooking. Fresh food can change its color and even deteriorate.

If the temperature in the oven is too high, e.g. directly after another program, you will not be able to use this function. Ready at and Start at will not appear on the display if this is the case. Open the oven door until the appliance has cooled down.

A Ready at time cannot be entered if you are using the roast probe. When using the roast probe, the end of the cooking duration is determined by when the set core temperature is reached. Only Start Later can be selected.

Turning on and off automatically

To turn a cooking program on and off automatically, you have a choice of how to enter the time parameters:

– Duration and Ready at

– Duration and Start at

Example: It is now 11:45 am. The food takes 5 minutes to cook and needs to be ready at 12:30 pm.

■ Set a time of "00:05" in the Duration field.

■ Set a time of "12:30" in the Ready at field.

■ Confirm with OK.

Start at is calculated automatically. The cooking duration entered is added to the preheating time calculated by the steam oven.

Start at 12:18 appears on the display. The cooking process will start automatically at this time.

Operation: Steam cooking

Sequence of an automatic cooking process

Up until the start time the mode, the selected temperature, cooking duration (time left), Start at, and the start time will appear in the display.

After the start time, you can see the temperature increasing in the display during the preheating phase until the set temperature is reached. Once this temperature is reached a buzzer will sound, if this option has been switched on (see "Settings - Buzzer tones").

After the preheating phase, the cooking duration (time left) will count down on the display. The last minute counts down in seconds.

At the end of the cooking duration, the steam generator will switch off. A signal will sound (see "Settings - Volume - Buzzer tones") when the buzzer is switched on.

Steam Reduction (for temperatures over approx. 175°F / 80°C) and Program Finished will appear in the display.

You have the option to save the program as a Favorite (see "Favorites") or to increase the cooking duration using Change. Tap "Back" to go back to the main menu.

Changing settings during a cooking process

■ Select Change.

The following will appear in the display:

- Temperature
- Duration
- Ready at
- Start at

If the temperature in the oven is too high Ready at and Start at are not displayed.

- Additional Settings

Select Additional Settings to change the oven mode.

Changing the temperature

- Change the temperature.
- Confirm with OK.

The cooking program will restart with the new temperature.

You can also permanently reset the recommended temperature to suit your personal cooking habits (See "Settings - Recommended Temperatures").

Changing the cooking duration

- Change the duration.
- Confirm with OK.

The program will restart using the new duration.

Operation: Steam cooking

Deleting a finish time

- In the field Ready at set the time to "----".
- Confirm with OK.

The finish time is now deleted.

The program will start using the duration set.

Changing the oven mode

- Select Additional Settings.
- Select Change Operating Mode.
- Select the desired mode.

The new mode will appear on the display together with its recommended temperature.

- Change the temperature, if necessary.
- Set a different cooking duration if necessary.
- Confirm with OK.

The oven mode has been changed.

Canceling cooking

- Touch "Back" twice.

Cancel Cooking? appears on the display.

- Select Yes.



The main menu will appear. Any cooking durations set will be deleted.

Operation: Combination cooking mode

Combi Steam  works by combining dry heat and steam. You can combine up to ten cooking stages in a combination mode program. You can set the temperature, moisture level, and duration or core temperature (when using the roast probe) for each cooking stage.

The cooking program will be carried out in the order in which the individual stages are entered.

The following operating modes are available:

- Convection Bake 
- Surround 
- Maxi Broil 

The roast probe cannot be used with Maxi Broil .

You cannot cook with a core temperature after a cooking stage using Maxi Broil .

Operation: Combination cooking mode

A fault can occur if the drain is blocked.



Check that the drain filter is correctly in place before each program as large food residues can clog the drain.

Quick guide

The following example describes a cooking program with 3 cooking stages.

- Turn the steam oven on .

The main menu appears on the display.

- Insert the roast probe if required into the food (see "Roast probe").
- Put the food in the oven.
- When cooking on the rack, insert the universal tray underneath it.
- Select Operating Modes .
- Select Combi Steam .

Cooking stage 1

Convection Bake  / **Surround** 

- Select Set the Duration.
- Set the temperature, duration and moisture level.
- Confirm with OK.

or

- Select Set the Core Temperature.
- Set the temperature, core temperature and moisture level.
- Confirm with OK.

A message will appear on the display:

- Select Add.

Maxi Broil 

- Set the level, duration and moisture level.
- Confirm with OK.

A message will appear on the display:

- Select Add.

Cooking stage 2

- Select the desired mode.
- Select the required settings (see cooking stage 1).
- Confirm with OK.

A message will appear on the display:

- Select Add.

Operation: Combination cooking mode

Cooking stage 3

- Select the desired mode.
- Select the required settings (see cooking stage 1).
- Confirm with OK.

A message will appear on the display:

- Select Finish.

A summary of your settings will appear in the display.

- Check the settings and confirm with OK or select Change to correct the settings or to add further cooking stages.

When you tap OK to confirm, the following will appear in the display:

- Start Now
- Ready at
- Start at

A Ready at time cannot be entered if you are using the roast probe. When using the roast probe, the end of the cooking duration is determined by when the set core temperature is reached. Only Start Later can be selected.

- Change Cooking Stages
- If you wish to save your settings as a user program select Save and enter a program name (see "User programs").
- Start the cooking process immediately or alter further settings as necessary (see "Additional functions").

At the end of the cooking duration

- Steam Reduction (only with temperatures of approx. 175-210°F / 80-100°C and a 100% humidity setting) and Program Finished will appear in the display.
- The fan remains on.
- A buzzer will sound if turned on (see "Settings - Volume - Buzzer tones").

You have the option of saving the program as a user program (see "User programs"). Tap "Back" to go to the main menu.

Burn hazard!

You could burn yourself on the oven interior walls, spilled food and accessories

Use pot holders when removing hot food from the oven.

- Wait until Steam Reduction goes out on the display before opening the door and removing the food.

Operation: Combination cooking mode

After use

- Remove the water container by pushing upwards slightly as you take it out of the appliance and empty it.
- Switch the steam oven off ①.

Following a cooking program with steam, **Appliance Rinsing** will appear in the display after the steam oven has been switched off.

This process should be carried out every time to flush any remaining food deposits out of the system.

- Follow the instructions in the display.
- After each use, clean and dry the whole appliance as described in "Cleaning and care."
- Leave the appliance door open until the oven compartment is completely dry.

Interrupting operation

Operation is interrupted as soon as the door is opened. The heating will be turned off and the cooking duration remaining stored in memory.

Burn hazard!

Steam can escape when the door is opened.

Step back and wait until the steam has dissipated.

Burn hazard!

You could burn yourself on the oven interior walls, spilled food and hot steam.

Use pot holders when inserting, removing or turning hot food, or when adjusting shelves, etc. in a hot oven.

Operation will resume when the door is closed.

The oven will heat up again and the display will show the temperature of the cooking compartment as it rises. Once the set temperature has been reached, the display will change to show the cooking duration remaining as it counts down.

For cooking processes with a 100% humidity setting and temperatures up to 210°F / 100°C:

The cooking process will be ended early if the door is opened during the last minute of cooking (55 seconds standing time).

Operation: Combination cooking mode

Additional functions

Setting additional durations

You have placed the food in the oven and selected the settings for the cooking process.

You can set the program to turn off or on and off automatically by entering Ready at or Start at.

– Ready at

You specify the time you want cooking to stop.

– Start at

You specify the time you want cooking to start.

Cooking results can be impaired if there is a long delay between the food being placed in the oven and the start of cooking. Fresh food can change its color and even deteriorate.

If the temperature in the oven is too high, e.g. directly after another program, you will not be able to use this function. Ready at and Start at will not appear on the display if this is the case. Open the oven door until the appliance has cooled down.

A Ready at time cannot be entered if you are using the roast probe. When using the roast probe, the end of the cooking duration is determined by when the set core temperature is reached. Only Start Later can be selected.

Turning on and off automatically

To turn a cooking program on and off automatically, you have a choice of how to enter the time parameters:

– Duration and Ready at

– Duration and Start at

Example: It is now 11:45 am. The food takes 5 minutes to cook and needs to be ready at 12:30 pm.

■ In cooking stage 1, set a cooking duration of 5 minutes (see "Quick guide").

When you have selected the settings for the cooking process:

■ Select Ready at and set "12:30."

■ Confirm with OK.

Start at is calculated automatically.

Start at 12:25 appears on the display. The cooking process will start automatically at this time.

Operation: Combination cooking mode

Sequence of an automatic cooking process

Up until the start time, the mode, the selected temperature and moisture, cooking duration (time left), Start at, and the start time will appear in the display.

After the start time, you can see the temperature increasing in the display during the preheating phase until the set temperature is reached. Once this temperature is reached a buzzer will sound, if this option has been switched on (see "Settings - Buzzer tones").

After the preheating phase you can follow the time counting down in the display. The last minute counts down in seconds.

At the end of the cooking process the steam generator and oven compartment lighting will switch off. A buzzer or a melody will sound (see "Settings - Volume - Buzzer tones").

Steam Reduction (only with temperatures of approx. 175-210°F / 80 - 100°C and a 100% humidity setting) and Program Finished will appear in the display.

You have the option of saving the program as a user program (see "User programs"). Tap "Back" to go to the main menu.

Changing settings during a cooking process

- Select Change.

The following will appear on the display:

- all individual cooking stages
- Add Cooking Stages

The setting specified for a cooking stage can be changed or more cooking stages can be added to the program.

- Select the desired cooking stage or Add Cooking Stages.
- Alter the cooking stages as you wish (see "Simple operation") and confirm with OK.

A summary of your settings will appear on the display.

- Check the settings and confirm with OK or select Change to correct the settings or to add further cooking stages.

Operation: Combination cooking mode

Canceling cooking

- Tap "Back".

Cancel Cooking? appears on the display.

- Select Yes.

The main menu will appear. Any cooking durations set will be deleted.

Operation: Functions without steam



You do not necessarily need to enter a cooking duration for operating modes which do not use steam. If no duration is entered, operation starts automatically as soon as the temperature has been confirmed or after 15 seconds. The steam oven will switch off automatically after a maximum 12 hours of operation, or after a maximum 6 hours for broiling modes.

If a cooking duration is entered, it starts to count down when the preheating phase begins.

You can choose to inject steam. The steam will be injected as soon as you have selected this option, Burst of steam active will appear in the display. It takes about 1 minute. There is no limit to the number of times you can inject a burst of steam.

The following operating modes are available:

- Convection Bake 
- Surround 
- Intensive 
- Bake 
- Browning 
- Maxi Broil 
- Broil 
- Convection Broil 
- Humidity Plus 
- Gentle Bake 

The roast probe cannot be used with the Maxi Broil  and Broil  modes.

Operation: Functions without steam

The grease filter must be removed for baking as otherwise this can result in uneven browning. Exception: Fit the grease filter in the back wall when baking open deep fresh fruit flans, e.g. plum or damson or pizza with lots of topping.

- Alter the recommended or core temperature or level, if necessary.

The recommended temperature will be automatically accepted within a few seconds.
If required, select **Change** to go back to the temperature selection option.

Quick guide

- Remove the grease filter from the back wall.
 - Switch the steam oven on ①.
- The main menu appears in the display.
- Insert the roast probe into the food if required (see "Roast probe").
 - Put the food in the oven.
 - Select Operating Modes .
 - Select the desired operating mode.

When the operating mode is selected, the following will appear in the display:

- Temperature or Level
- Core Temp.
(This option only appears when you are using the roast probe.)
- Additional Settings

- Set further settings as necessary (see "Additional functions")
- Confirm with OK.

The cooking program will start. The oven heating, lighting, and fan will switch on.

Operation: Functions without steam

After the cooking program



Danger of burning!

You could burn yourself on the oven interior walls, spilled food and accessories.

Use pot holders when removing hot food from the oven.

- Remove the food from the oven.
- Switch the steam oven off ①.
- After each use, clean and dry the whole appliance as described in "Cleaning and care."
- Leave the appliance door open until the oven compartment is completely dry.

Interrupting operation

Operation is interrupted as soon as the door is opened. The heating will be switched off.



Burn hazard!

You could burn yourself on the oven interior walls, spilled food and accessories

Use pot holders when inserting, removing or turning hot food, or when adjusting shelves, etc. in a hot oven.

Operation will resume when the door is closed.

The steam oven will heat up again and the display will show the temperature in the oven compartment as it rises.

Operation: Functions without steam

Additional functions

You have placed the food in the oven, selected a function, and set the temperature or broil level.

By selecting Additional Settings you can adjust cooking durations and adjust additional settings.

- Select Change.
- Select Additional Settings.



Additional menu items will appear. You can select or change these options for the cooking program:

- Duration
- Ready at

A Duration and Ready at time cannot be entered if you are using the roast probe. When using the roast probe, the end of the cooking duration is determined by when the set core temperature is reached.

- Start at
Only appears when either Duration or Ready at have been set or if you are using the roast probe.

- Rapid PreHeat

Only appears if you have set a temperature of more than 210°F / 100°C in Convection Bake  and Surround .

- Change Operating Mode

Setting additional durations

By entering Duration, Ready at or Start at you can automatically turn the cooking program on or off.

- Duration

Enter the cooking duration required. You can select a duration of between 1 minute and 12 hours, or 1 minute and 6 hours for broiling modes.

- Ready at

You specify the time you want cooking to stop.

- Start at

You specify the time you want cooking to start.

When baking, the oven should not be set to start a long time off. Otherwise the cake mixture or dough will dry out, and the raising agents will lose their effectiveness.

Cooking results can be impaired if there is a long delay between the food being placed in the oven and the start of cooking. Fresh food can change its color and even deteriorate.

Operation: Functions without steam

Turning off automatically

To switch off a cooking process automatically, you can set either **Duration** or **Ready at**.

Example: It is now 11:45 am. The food takes 30 minutes to cook and needs to be ready at 12:15 pm.

- **Select Change.**
- **Select Additional Settings.**
- **Set a time of "00:30" in the **Duration** field.**
- **Confirm with OK.**

or

- **Select Change.**
- **Select Additional Settings.**
- **Set a time of "12:15" in the **Ready at** field.**
- **Confirm with OK.**

The oven will switch off automatically after this duration has elapsed or the time set has been reached.

Turning on and off automatically

We recommend using automatic switch-on and switch-off when roasting.

To turn a cooking program on and off automatically, you have a choice of how to enter the time parameters:

- **Duration and Ready at**
- **Duration and Start at**
- **Ready at and Start at**

Example: It is now 11:30 am. The food takes 30 minutes to cook and needs to be ready at 12:30 pm.

- **Select Change.**
- **Select Additional Settings.**
- **Set a time of "00:30" in the **Duration** field.**
- **Set a time of "12:30" in the **Ready at** field.**
- **Confirm with OK.**

Start at is calculated automatically.

Start at 12:00 appears on the display. The cooking process will start automatically at this time.

Operation: Functions without steam

Sequence of an automatic cooking process

Up until the start time the mode, the selected temperature, cooking duration (time left), Start at, and the start time will appear in the display.

After the start time, you can see the temperature increasing in the display during the preheating phase until the set temperature is reached. Once this temperature is reached a buzzer will sound, if this option has been switched on (see "Settings - Buzzer tones").

After the preheating phase you can follow the time counting down in the display. The last minute counts down in seconds.

At the end of the cooking process, the oven compartment heating will switch off. A buzzer will sound (see "Settings - Volume - Buzzer tones"). Program Finished will appear in the display.

You have the option to save the program as a Favorite (see "Favorites") or to increase the cooking duration using Change. Tap "Back" to go back to the main menu.

Rapid PreHeat

Rapid PreHeat can be used to speed up the preheating phase.

This function switches on automatically if you set the temperature above 210°F / 100°C for Convection Bake  and Surround .

– On

The Browning / Broiling and convection heating elements turn on together with the fan to enable the steam oven to reach the required temperature as quickly as possible.

– Off

Only the heating elements associated with the cooking mode are turned on.

Rapid PreHeat should be switched off when cooking pizza and delicate items (e.g. sponge or pastry). These will get brown too quickly on the top. Switch off the function when preparing this kind of food.

You can switch off Rapid PreHeat for the respective cooking process.

Operation: Functions without steam

Switching off Rapid PreHeat

- Select Additional Settings.

In Rapid PreHeat, On will appear.

- Select On.

In Rapid PreHeat, Off will appear.

- Confirm with OK.



Rapid PreHeat has been switched off.
Preheating appears in the display.

Changing the operating mode

You can change the operating mode during operation.

- Select Change.
- Select Additional Settings.
- Select Change Operating Mode.
- Select the desired operating mode.

The new mode and the relevant recommended temperature will appear in the display.

Any cooking durations set will be adopted. Exception: If you change to Combi Steam , Steam Cooking  or Sous-vide , you must enter another cooking duration.

- Change the temperature and/or cooking duration, if necessary.
- Confirm with OK.

The oven mode has been changed.

Changing settings during a cooking process

- Select Change.

The following will appear in the display:

- Temperature or Level
- Core Temp.
(This option only appears when you are using the roast probe.)
- Additional Settings
(See "Additional functions.")

Changing the temperature

- Change the temperature.
- Confirm with OK.

The steam oven will be heated up or cooled down until the altered temperature is reached.

You can also permanently reset the default temperature to suit your personal cooking habits (See "Settings - Default temperatures").

Changing the core temperature

- Change the core temperature.
- Confirm with OK.

Changing the broil level

- Change the level.
- Confirm with OK.

The program will restart with the new broil level.

Operation: Functions without steam

Changing the cooking duration

- Change the duration.
- Confirm with OK.

The program will restart using the new duration.

Deleting a cooking duration

- In the field *Duration* set the time to "----".
- Confirm with OK.

The program will continue with the set temperature.

Deleting a finish time

- In the field *Ready at* set the time to "----".
- Confirm with OK.

The finish time is now deleted.

The program will start using the duration set.

Canceling cooking

- If you have not set a duration, tap "Back" twice.

The main menu will appear.

- If you have set a duration or are using the roast probe, tap "Back" twice.

Cancel Cooking? appears on the display.

- Select Yes.

The main menu will appear. Any cooking durations or core temperature set will be deleted.

MyMiele

MyMiele can be used to personalize your steam oven by inputting frequently used processes.

It is particularly useful with MasterChef program as you do not need to work through every screen in order to start your program.

You can also set processes that you have entered into MyMiele to appear in the Start screen (see "Settings – Start screen").

To add an entry

You can add up to 20 entries.

■ Select MyMiele  .

■ Select Add entry.

You can select options from the following categories:

– Operating Modes

– MasterChef Auto

– Special Modes 

– Favorites 

– Maintenance 

■ Confirm with OK.

A box will appear in the list next to the selected option, together with a symbol to show which category it was selected from.



■ Proceed as above for further entries as required. You can only chose subitems that have not already been selected.

Editing MyMiele

After selecting **Edit** you can

- add entries, if MyMiele contains less than 20 entries,
- delete entries,
- sort entries, if MyMiele contains more than 4 entries.



Deleting entries

- Select MyMiele  .
- Select **Edit**.
- Select **Delete** entry.
- Select the entry that you want to delete.
- Confirm with **OK**.

The entry is removed from the list.

Sorting entries

If there are more than 4 entries, you can change the order of the entries.

- Select MyMiele  .
- Select **Edit**.
- Select **Sort** entry.
- Select the entry.
- Select the position you want to move it to.
- Confirm with **OK**.

The entry will now appear in the position selected.

MasterChef

Your steam oven has a number of MasterChef programs that enable you to achieve excellent cooking results with ease. Simply select the appropriate program for the type of food you are cooking and follow the instructions on the display.

List of automatic programs

You can select MasterChef under MasterChef .

- Vegetables
- Fish
- Meat
- Bread
- Rolls
- Cakes/Pastries
- Pizza & Quiche
- Bakes & Gratins
- Rice
- Grains
- Pasta
- Legumes
- Eggs
- Desserts
- Fruit
- Mushrooms
- Sausage
- Shellfish
- Mussels
- Special

Using the MasterChef programs

- Select MasterChef .

A list of food types will appear on the display.

- Select the desired food category.

The MasterChef programs available for the food category selected will appear.

- Select the desired MasterChef program.

Each step you need to take before starting the MasterChef program will appear on the display.

In some programs, you will be prompted on when to add food to the oven. Follow and confirm these instructions.

Notes on using these programs

- The degree of doneness and browning levels are represented by a bar with seven segments. The factory setting is a medium doneness and browning. It will be highlighted. To change the setting simply move the highlighting to the left or the right.
- MasterChef Gourmet programs: cooking at a low temperature over a long period for tender results.
- The weights shown refer to the weight per piece. You can cook a piece of salmon with a weight of ½ lb (250 g) or 10 pieces of salmon with a weight of ½ lb (250 g) at the same time.
- The oven interior needs to be at room temperature before starting a MasterChef program.
- When placing food in an already hot steam oven, be very careful when opening the door. Hot steam can escape. Step back from the steam oven and wait until the steam has dissipated. When putting cooking pans or the drip tray into the oven or taking them out, take care not to spill the contents. Avoid contact with hot steam, and do not touch the hot oven interior walls. Danger of burning and scalding.
- Please refer to recipes for information on suitable baking containers.
- For some MasterChef programs, the start time can be delayed using Start at or Ready at.

MasterChef

- To end a MasterChef automatic program early, turn the steam oven off completely by touching "Back"..

Cancel Cooking? will appear on the display. If Yes is selected, the main menu will be shown again.

- If the food is not cooked enough by the end of an MasterChef program, select Continue cooking or Continue baking.
- MasterChef programs can also be saved as Favorites.

Search

You can search MasterChef by food type and by the name of the MasterChef program.

This search is a full-text search and can also be used to search for parts of words.

- Select MasterChef .

A list of food types will appear on the display.

- Select Search.
- Use the keyboard to type in the search text, e.g. "Fish".

The number of hits will be shown in the bottom right of the display.

If no match is found or if there are more than 40 matches, the hits field will be deactivated and you will need to change the search text.

- Select hits.

The food types and MasterChef program available will then appear.

- Select the MasterChef program or the food type, and choose the MasterChef program
- Follow the instructions on the display

You can create and save up to 20 of your own programs.

- Each one can have up to 10 cooking stages. This enables you to save your favorite or most frequently used recipes very accurately. You can make individual settings for each stage.
- You can enter a program name for your recipe.

When you next select the program, it will start automatically.

There are different ways of creating a Favorite:

- At the end of running a MasterChef Program, save it as a separate program.
- After running a program with a set duration, select **Save**.

Then name the program.

Creating a Favorite

- Select **Favorites** .
- Select **Create Program**.

You can now specify the settings for cooking stage 1.

Follow the instructions on the display:

- Select and confirm the cooking mode, temperature, broil level, the moisture level if necessary, and the duration or core temperature.

The settings for the first cooking stage have now been set.

You can add more cooking stages, for example, if you want to add another cooking mode to follow on from the first:

- Select **Add** and proceed as for the first cooking stage.
- When you have completed setting the cooking stages, select **Finish**.

A summary of your settings will appear on the display.

- Check the settings and confirm with **OK** or select **Change** to correct the settings or to add further cooking stages.
- Select **Save**.
- Enter the program name using the keyboard.

You can add a line break for longer program names using the  symbol.

- Once you have entered the program name select **Save**.

Favorites

A message will appear in the display confirming that the program has been saved.

- Confirm with OK.

You can start the saved program immediately, delay the start or change the cooking stages.

More information regarding Change Cooking Stages can be found in "Changing favorites".

Starting a Favorite

- Put the food in the oven.

- Select Favorites .

The program names will appear in the display.

- Select the desired program.

You can start the saved program immediately, delay the start, or show the cooking stages.

- Start Now

The program will start. The oven compartment lighting and the steam generator will switch on immediately.

- Start Later

This option only appears if you are using the roast probe. You can specify when you want the program to start.

- Ready at

You can set the time at which the cook program should end.

- Start at

You can set the time at which the cooking program should start.

- Display Stages

A summary of your settings will appear in this display. You can adjust the setting under Change (see "Changing Favorites").

- Select the desired mode.

The program will start according to the specified start or finish time.

Changing Favorites

Changing cooking stages

Cooking stages in a MasterChef program that have been saved under a different name cannot be changed.

- Select Favorites .
- Select Edit.
- Select Change Program.
- Select the desired program.
- Select Change Cooking Stages.

The setting specified for a cooking stage can be changed or more cooking stages can be added to the program.

- Select the desired cooking stage or Add Cooking Stages.
- Change the program as desired (see "Creating a Favorite") and confirm by touching OK.

A summary of your settings will appear in the display.

- Confirm the settings and then select Save.

The changes or added cooking steps in your program will be saved.

Changing the name

- Select Favorites .
- Select Edit.
- Select Change Program.
- Select the desired program.
- Select Change name.
- Change the name (see "Creating a Favorite") and select Save.

A message will appear in the display confirming that the program has been saved.

- Confirm with OK.

Favorites

Deleting a Favorite

- Select Favorites .

The program names will appear in the display.

- Select Edit.
- Select Delete Program.
- Select the desired program.
- Confirm with OK.

The program is deleted.

You can delete all of your Favorites at the same time (see "Settings - Factory Default - Favorites").

Using the  sensor, you can enter a timer duration (e.g. when boiling eggs on the cooktop) or an alarm time, i.e. a specific time.

Two alarms can be set simultaneously, two timer durations or an alarm and a timer duration.

Using the alarm

The alarm can be used to set a specific time at which a buzzer will sound on the steam oven.

Setting the alarm

If Time | Display | Off has been selected, you will need to switch the steam oven on before you can set the alarm. The time for the alarm will now appear in the display when the steam oven is switched off.

- Tap "Timer".
- Select New Alarm.
- Set the time for the alarm.
- Confirm with OK.

When the steam oven is switched off, the alarm time and  will appear instead of the time of day.

If a cooking procedure concludes at the same time or if you are in a different menu, the alarm time and  will appear in the top right of the display.

At the set alarm time

-  will flash next to the time in the display.
- A buzzer will sound if turned on (see "Settings - Volume - Buzzer tones").
- Select "Timer" or the alarm in the top right-hand corner of the display to switch off the acoustic and optical signals.

Changing an alarm

- Select the alarm in the top right-hand corner of the display or select "Timer" and then the alarm you want.

The alarm selected appears.

- Set the new time for the alarm.
- Confirm with OK.

The altered alarm will appear in the display.

Deleting an alarm

- Select the alarm in the top right-hand corner of the display or select "Timer" and then the alarm you want.

The alarm selected appears.

- Select *Reset*.

The alarm will be deleted.

- Confirm with OK.

Alarm + Timer

Using the Timer

The timer can be used to time any activity in the kitchen, e.g. boiling eggs.

The timer can also be used at the same time as a cooking program if a start and finish time have been set, e.g. a reminder to stir the dish or add seasoning.

A maximum timer duration of 9 hours, 59 minutes and 59 seconds can be set.

Setting the timer



If you want to use the timer and Time | Display | Off has been set, you will need to switch the steam oven on before you can set the timer. The timer can then be seen counting down on the display when the steam oven is switched off.

- Tap "Timer".
- Select New Timer Time.
- Set the timer for the required time.
- Confirm with OK.

When the steam oven is switched off, the timer time counts down in the display and  appears instead of the time of day.

If you are cooking at the same time or if you are in a different menu, the timer duration and  will appear in the top right-hand corner of the display.

At the end of the timer

-  flashes in the display.
- The time starts counting upwards.
- A buzzer will sound if turned on (see "Settings - Volume - Buzzer tones").
- Select  or the timer duration in the top right-hand corner of the display to switch off the acoustic and optical signals.

Resetting the timer

- Select the timer duration in the top right-hand corner of the display or tap "Timer" and then the duration you want.

The time previously set appears

- Set a new timer duration.
- Confirm with OK.

The altered timer duration will start to count down immediately.

Canceling the timer

- Select the timer duration in the top right-hand corner of the display or tap "Timer" and then the duration you want.

The time previously set appears

- Select Reset.

The timer duration is now cancelled.

- Confirm with OK.

The "General Notes" section contains general information. You will find more detailed information about particular foods and how to cook them in the other sections.

The advantages of cooking with steam

Almost all vitamins and minerals are retained as the food is not immersed in water.

Cooking with steam also retains the true taste of the food better than conventional cooking. We therefore recommend seasoning the food after it has been cooked. Food also retains its fresh, original color.

Suitable containers

Cooking pans

This steam oven is supplied with stainless steel cooking pans. Other containers, in a variety of sizes, both perforated and solid, are available as optional extras (see "Optional accessories"). This enables you to choose the most suitable container for the food you are preparing.

It is best to use perforated pans for **Steam Cooking**. The steam can reach the food from all sides and the food is cooked evenly.

Using your own cookware

You can also use your own cookware. However, please note the following:

- It must be suitable for using in an oven and must be steam resistant. Plastic cookware can only be used for steam cooking if the manufacturer has stated that they are suitable for such use.
- Thick-sided dishes made from porcelain, china or stoneware, for example, are not as suitable for steam cooking. They do not conduct heat well and as a result cooking durations will be considerably longer than those given in the charts.
- Place the cookware on the rack or in a suitable cooking container and not on the oven floor.
- Ensure that there is a gap between the upper rim of the dish and the top of the cooking compartment to allow sufficient steam into the container.

General notes

Shelf level

You can select any shelf level. You can also cook on several levels at the same time. This will not alter the cooking duration.

When using more than one deep cooking container at the same time, it is best to offset them on their runners and to leave at least one level free in between them.

Always insert cooking containers and the rack between the rails of the shelf level supports so that they cannot tip.

Frozen food

The heating up phase for frozen food is longer than for fresh food. The greater the quantity of frozen food, the longer the preheating phase.

Temperature

A maximum temperature of 210°F / 100°C is reached when steam cooking is taking place. Most types of food will cook at this temperature. Some more delicate types of food, such as soft fruit, must be cooked at lower temperatures as otherwise they will burst. More information is given in the relevant section.

Cooking duration

In general, the cooking durations for cooking with steam are the same as for cooking food in a saucepan. More information about any factors which may affect the cooking duration is given in the relevant sections.

The quantity of food does not affect the cooking time. 1 lb of potatoes will take the same time to cook as ½ lb.

The durations given in the charts are guidelines only. We recommend selecting the shorter cooking duration quoted to start with. If food is not cooked sufficiently after the shorter time it can be put back in the oven and cooked for longer.

Cooking with liquid

When cooking with liquid only fill the cooking pan $\frac{2}{3}$ full to prevent the liquid spilling when the cooking pan is removed from the oven.

Your own recipes - Steam cooking

Food and recipes which are prepared in pot or a pan can also be cooked in the steam oven. The cooking times in the steam oven will be the same. Please note that food will not be brown or crisp when cooking with steam.

Wire oven rack / universal tray

Use the rack above the universal tray when roasting or broiling. The cooking liquids will collect in the tray and can then be used to make a gravy or sauce.

If you are using the universal tray with the rack on top, e.g. for broiling, insert the tray between the rails of the side runners and the rack will automatically slide in above them. When removing them from the oven pull both parts out together.

Non-tip safety notches

The wire oven rack and universal tray have non-tip safety notches in the middle which prevent them being pulled right out when they only need to be partially pulled out. The tray and rack can then only be taken out of the oven by raising them upwards and then pulling them out.

Steam cooking

Vegetables

Fresh food

Prepare fresh vegetables in the usual way, i.e. wash, clean and cut them up.

Frozen food

Frozen vegetables do not need to be defrosted beforehand unless the vegetables have been frozen together in a block.

To cook frozen vegetables, program the same time as for fresh ones.

Break up the larger, frozen together pieces. Please refer to the cooking times on the packaging.

Cooking pan

Food such as peas or asparagus spears, which have little or no space between them, will take longer to cook because the steam has less space to work in. For an even result, it is best to use a shallow container for these types of food, and only fill it about 1-2" (3-5 cm) deep. When cooking large quantities divide the food between 2 or 3 shallow containers rather than using one deep one.

Different types of vegetables which take the same length of time to cook can be cooked together in one cooking pan.

Use solid containers for vegetables which are cooked in liquid, e.g. cabbage.

Shelf level

When cooking vegetables with a distinctive color (e.g. beets) in a perforated container at the same time as cooking other foods in other containers, place the drip tray directly underneath the perforated container to catch any drips and therefore avoid any color transfer.

Cooking duration

As with conventional methods, when cooking vegetables with steam, the cooking duration will depend on the size and also whether you want the vegetables to be al dente or soft/well done. Example:

firm potatoes, cut into quarters
= approx. 17 minutes
firm potatoes, cut in half
= approx. 21 minutes

Settings

MasterChef Auto | Vegetables | ... | Steam Cooking

or

Operating Modes | Steam Cooking
Temperature: 210°F / 100°C
Duration: see chart

Steam cooking

The durations given in the charts for fresh vegetables are guidelines only. We recommend selecting the shorter cooking duration quoted to start with. If vegetables are not cooked sufficiently after the shorter time, they can be put back in the steam oven and cooked some more.

Vegetables	🕒 [min]
Artichokes	32–38
Cauliflower, whole	27–28
Cauliflower, florets	8
Beans, green	10–12
Broccoli, florets	3–4
Carrots, whole	7–8
Carrots, halved	6–7
Carrots, chopped	4
Chicory, halved	4–5
Chinese cabbage, chopped	3
Peas	3
Fennel, halved	10–12
Fennel, cut into strips	4–5
Kale, chopped	23–26
Waxy potatoes, peeled	
whole	27–29
halved	21–22
quartered	16–18
Fairly waxy potatoes, peeled	
whole	25–27
halved	19–21
quartered	17–18
Floury potatoes, peeled	
whole	26–28
halved	19–20
quartered	15–16
Kohlrabi, cut into sticks	6–7

Steam cooking

Vegetables	🕒 [min]
Pumpkin, diced	2–4
Corn on the cob	30–35
Swiss chard, chopped	2–3
Peppers, diced / cut into strips	2
Potatoes cooked in skins, firm	30–32
Mushrooms	2
Leeks, chopped	4–5
Leek, halved lengthwise	6
Romanesco, whole	22–25
Romanesco, florets	5–7
Brussels sprouts	10–12
Red beets, whole	53–57
Red cabbage, chopped	23–26
Black salsify, whole	9–10
Celery root, cut into batons	6–7
Green asparagus	7
White asparagus, whole	9–10
Carrots, chopped	6
Spinach	1–2
Pointed cabbage, chopped	10–11
Celery, chopped	4–5
Rutabaga, chopped	6–7
White cabbage, chopped	12
Savoy cabbage, chopped	10–11
Zucchini, sliced	2–3
Snap peas	5–7

🕒 Cooking duration

Meat

Fresh food

Prepare the meat as usual.

Frozen food

Meat should be thoroughly defrosted before cooking in the steam oven (see "Defrosting").

Preparation

For meat which needs to be seared before being cooked, e.g. for a stew, sear the meat in a pan on the cooktop first.

Cooking duration

The cooking time depends on the thickness and consistency of the food. The thicker the meat, the longer the cooking time.

Tips

- Use a perforated pan to retain the **flavor** when cooking meat. Place a solid pan or universal tray underneath to catch the juices. You can use these to make a gravy or freeze them for later use.
- Boiling chicken, pork rind, meat, ribs and meat bones can be used to make **stock**. Place the meat together with some mixed vegetables in a solid cooking pan and add cold water. The longer the cooking duration, the stronger the stock.

Settings

MasterChef  | Meat | ... | Steam Cooking

or

Operating Modes  | Steam Cooking 

Temperature: 210°F / 100°C

Duration: see chart

Steam cooking

The cooking times given in the chart are guidelines only. We recommend selecting the shorter cooking time to start, additional time can be added if necessary.

Meat	🕒 [min]
Shank, covered with water	110–120
Pork knuckle	135–140
Chicken breast filet	8–10
Leg (Joint)	105–115
Prime rib, covered with water	110–120
Veal strips	3–4
Smoked pork chops	6–8
Lamb stew	12–16
Spring chicken	60–70
Roulade of turkey	12–15
Turkey breast	4–6
Cross rib, covered with water	130–140
Beef stew	105–115
Whole chicken, covered with water	80–90
Boiled beef	110–120

🕒 Cooking duration

Sausage

Settings

MasterChef  | Sausage | ... | Steam Cooking

or

Operating Modes  | Steam Cooking 

Temperature: 194°F / 90°C

Duration: see chart

Sausage	 [min]
Boiled sausage	6–8
Pork sausage	6–8
Veal sausage	6–8

 Cooking duration

Fish

Fresh food

Prepare fresh fish in the usual way, i.e. clean, gut and filet.

Frozen food

Frozen fish should be slightly defrosted before cooking.

Preparing for use

Add some lemon or lime juice to fish before cooking. The citric acid helps the flesh stay firm.

It is not necessary to season fish when cooking with steam as this method retains the minerals which give the fish its unique flavor.

Cooking pans

If using a perforated pan, grease it first.

Shelf level

When cooking fish in a perforated container at the same time as cooking other types of food in other containers, place the container with the fish directly above the tray to catch any liquid and so avoid any transfer of tastes to other food.

Steam cooking

Temperature

185° F – 195° F / 85° C – 90° C

For gently cooking delicate types of fish, such as sole.

212° F / 100° C

For cooking firmer types of fish, e.g. cod and salmon.

Also for cooking fish in sauce or stock.

Cooking duration

The cooking duration depends on the thickness and the consistency of the food, and not on the weight.

The longer fish cooks, the firmer its flesh will become. Use the cooking durations given in the chart. If you find that the fish is not cooked sufficiently only cook it for a few minutes more.

When cooking fish in sauce or stock, we recommend that you increase the cooking duration quoted by a few minutes.

Tips

- Adding herbs and spices, such as dill, will help bring out the full flavor of the fish.
- Cook large fish in the swimming position. To help maintain the shape of the fish, place a small cup or similar upside down in the cooking pan, and arrange the fish bellyside down over the cup.

- You can use any fish scraps, e.g. fish heads, bones, tails etc to make a **fish stock**. Place the fish scraps together with some mixed vegetables in a solid cooking pan and add cold water. Cook at 212°F / 100°C for 60 to 90 minutes. The longer the cooking duration, the stronger the stock.

Settings

MasterChef Auto | Fish | ... | Steam Cooking

or

Operating Modes | Steam Cooking

Temperature: see chart

Duration: see chart

Steam cooking

The durations given in the chart are guidelines for fresh fish. We recommend selecting the shorter cooking duration quoted to start with. If the fish is not cooked sufficiently after the shorter time, it can be put back in the steam oven and cooked some more.

Fish	🌡️ [°F / °C]	🕒 [min]
Eel	212 / 100	5–7
Perch filet	212 / 100	8–10
Mahi Mahi filet	185 / 85	3
Trout, 1/2 lb (250 g)	195 / 90	10–13
Halibut filet	185 / 85	4–6
Cod filet	212 / 100	6
Carp, 3 lbs (1.5 kg)	212 / 100	18–25
Salmon filet	212 / 100	6–8
Salmon steak	212 / 100	8–10
Rainbow trout	195 / 90	14–17
Pangasius filet	185 / 85	3
Ocean Perch filet	212 / 100	6–8
Haddock filet	212 / 100	4–6
Flounder filet	185 / 85	4–5
Monkfish filet	185 / 85	8–10
Sole filet	185 / 85	3
Turbot filet	185 / 85	5–8
Tuna filet	185 / 85	5–10
Pike Perch filet	185 / 85	4

🌡️ Temperature / 🕒 Cooking duration

Steam cooking

Shellfish

Preparation

Defrost frozen shellfish before cooking with steam.

Peel, clean and wash the shellfish.

Cooking pan

If using a perforated pan, grease it first.

Cooking duration

The longer shellfish are cooked, the tougher they become. Use the cooking durations given in the chart.

When cooking shellfish in sauce or stock, we recommend that you increase the cooking duration quoted by a few minutes.

Settings



MasterChef  | Shellfish | ... | Steam Cooking

or

Operating Modes  | Steam Cooking 

Temperature: see chart

Duration: see chart

	 [°F / °C]	 [min]
Shrimp	195 / 90	3
Small shrimp	195 / 90	3
King prawns	195 / 90	4
Crayfish	200 / 95	10–15
Large shrimp	195 / 90	3

 Temperature /  Cooking duration

Mussels

Fresh food

 Warning - danger of food poisoning.

Only cook mussels which are closed. Do not eat mussels which have not opened after being cooked.

Steep fresh mussels in water for a few hours before cooking to rinse out any sand. Then scrub the mussels thoroughly to clean them.

Frozen food

Defrost frozen mussels before cooking.

Cooking duration

The longer mussels are cooked, the tougher they become. Use the cooking durations given in the chart.

Settings



MasterChef  | Mussels | ... | Steam Cooking

or

Operating Modes  | Steam Cooking 

Temperature: see chart

Duration: see chart

	 [°F / °C]	 [min]
Barnacles	212 / 100	2
Cockles	212 / 100	2
Bearded mussels	195 / 90	12
Scallops	195 / 90	5
Razor clams	212 / 100	2–4
Clams	195 / 90	4

 Temperature /  Cooking duration

Steam cooking

Rice

Rice swells when cooked and needs to be cooked in liquid. The proportion of rice to liquid will vary depending on the type of rice.

The rice absorbs all the liquid. Therefore none of the nutrients are lost.

Settings

MasterChef Auto | Rice | ... | Steam Cooking

or

Operating Modes | Steam Cooking

Temperature: 210°F / 100°C

Duration: see chart

	Ratio Rice to liquid	🕒 [min]
Basmati rice	1 : 1.5	15
Parboiled rice	1 : 1.5	23–25
Round grain rice		
Pudding rice	1 : 2.5	30
Risotto rice	1 : 2.5	18–19
Brown rice	1 : 1.5	26–29
Wild rice	1 : 1.5	26–29

🕒 Cooking duration

Pasta

Dry pasta

Dry pasta swell when cooked and needs to be cooked in liquid. The liquid must cover the pasta. Using hot liquid gives better results.

Increase the cooking time stated by the manufacturer by approx. $\frac{1}{3}$.

Fresh food

Fresh noodles and pasta, for example, from the store refrigerator, do not swell. Fresh pasta should be cooked in a greased perforated pan.

Separate any pieces of pasta which have stuck together and spread them out in the cooking pan.

Settings

MasterChef Auto | Pasta | ... | Steam Cooking

or

Operating Modes | Steam Cooking

Temperature: 210°F / 100°C

Duration: see chart

Fresh food	⌚ [min]
Gnocchi	2
Round Knoepfli	1
Ravioli	2
Spaetzle	1
Tortellini	2
Dry pasta, covered with water	
Flat pasta	14
Soup pasta	8

⌚ Cooking duration

Steam cooking

Dumplings

Ready-made dumplings in wrappers need to be covered completely with water. Otherwise they will not absorb enough water and will fall apart, even if steeped in water prior to cooking.

Cook fresh dumplings in a greased, perforated container.

Settings

MasterChef Auto | Pasta | ... | Steam Cooking

or

Operating Modes | Steam Cooking

Temperature: 210°F / 100°C

Duration: see chart

	 [min]
Steamed dumplings	30
Yeast dumplings	20
Boil-in-the-bag potato dumplings	20
Boil-in-the-bag bread dumplings	18–20

 Cooking duration

Grains

Grain swells when cooked and needs to be cooked in liquid. The proportion of grain to liquid will vary depending on the type of grain.

Grain can be cooked whole or cracked.

Settings

MasterChef Auto | Grains | ... | Steam Cooking

or

Operating Modes | Steam Cooking

Temperature: 210°F / 100°C

Duration: see chart

	Ratio Grain to liquid	🕒 [min]
Amaranth	1 : 1.5	15–17
Bulgur	1 : 1.5	9
Green spelt, whole	1 : 1	18–20
Green spelt, cracked	1 : 1	7
Oats, whole	1 : 1	18
Oats, cracked	1 : 1	7
Millet	1 : 1.5	10
Polenta	1 : 3	10
Quinoa	1 : 1.5	15
Rye, whole	1 : 1	35
Rye, cracked	1 : 1	10
Wheat, whole	1 : 1	30
Wheat, cracked	1 : 1	8

🕒 Cooking duration

Steam cooking

Legumes

Soak legumes for at least 10 hours in cold water before cooking. Soaking makes the legumes more digestible and shortens the cooking duration required. Soaked legumes must be covered with liquid during cooking.

Lentils do not need to be soaked before cooking.

With unsoaked legumes, a certain ratio of pulses to liquid is required depending on type.

Settings

MasterChef Auto | Legumes | ... | Steam Cooking

or

Operating Modes | Steam Cooking

Temperature: 210°F / 100°C

Duration: see chart

Soaked	
	🕒 [min]
Beans	
Kidney beans	55–65
Azuki beans	20–25
Black beans	55–60
Pinto beans	55–65
White beans	34–36
Peas	
Yellow peas	40–50
Green peas, shelled	27

🕒 Cooking duration

Steam cooking

Unsoaked		
	Ratio Legumes to liquid	🕒 [min]
Beans		
Kidney beans	1 : 3	130–140
Azuki beans	1 : 3	95–105
Black beans	1 : 3	100–120
Pinto beans	1 : 3	115–135
White beans	1 : 3	80–90
Lentils		
Brown lentils	1 : 2	13–14
Red lentils	1 : 2	7
Peas		
Yellow peas	1 : 3	110–130
Green peas, shelled	1 : 3	60–70

🕒 Cooking duration

Steam cooking

Eggs

Use a perforated container to prepare boiled eggs in the steam oven.

The eggs do not need to be pierced before cooking as they are gradually warmed during the preheating phase and so do not burst when they are cooked with steam.

When using a solid container for making egg dishes such as scrambled eggs, remember to grease it first.

Settings

MasterChef Auto | Eggs | ... | Steam Cooking

or

Operating Modes | Steam Cooking

Temperature: 210°F / 100°C

Fruit

Cook fruit in a solid container so that none of the juice is lost. If you wish to cook fruit in a perforated container, place a solid container directly underneath it to collect the juice.

Tip: You can use the collected juice to prepare a glaze.

Settings

MasterChef Auto | Fruit | ... | Steam Cooking

or

Operating Modes | Steam Cooking

Temperature: 210°F / 100°C

Duration: see chart

	 [min]
Apple chunks	1–3
Pears chunks	1–3
Cherries	2–4
Mirabelle plums	1–2
Nectarine / Peach chunks	1–2
Plums	1–3
Quince, diced	6–8
Rhubarb pieces	1–2
Gooseberries	2–3

 Cooking duration

Steam cooking

Menu Cooking - Manual

Before cooking meals with the "Menu Cooking" function, turn off the steam reduction system (see "Settings").

"Menu Cooking" is intended for cooking a whole meal containing types of food which have different cooking durations, e.g., fish filet with rice and broccoli. Each dish is placed in the oven at different times so that they are all ready at the same time.

Shelf level

When cooking fish or food with a distinctive color (e.g. beetroot) in a perforated container, place the perforated container directly above the drip tray / universal tray (depending on model) to avoid any transfer of flavor or color to other food and to prevent liquid dripping onto food below it.

Temperature

Whole meals should be cooked at a temperature of 212°F / 100°C as this is the temperature required to cook the majority of foods.

Do not cook a whole meal at the lowest temperature when different temperatures are required for different types of food, e.g. 185°F / 85°C for seabream and 212°F / 100°C for potatoes.

If the recommended cooking temperature for the food is 185°F / 85°C, for example, try cooking it at 212°F / 100°C and testing the result. Some delicate types of fish with a soft structure, e.g. sole and plaice will become very firm when cooked at 212°F / 100°C.

Cooking duration

If you are increasing the recommended temperature, shorten the cooking duration by approx. $\frac{1}{3}$.

Example

Rice	20 minutes
Tilapia filet	6 minutes
Broccoli	4 minutes

20 minutes minus 6 minutes = 14 minutes (first cooking duration: rice)

6 minutes minus 4 minutes = 2 minutes (second cooking duration: tilapia filet)

Time left = 4 minutes (third cooking duration: broccoli)

Cooking durations	20 min. - rice		
	6 min. - tilapia filet		
	4 min. - broccoli		
Setting	14 min.	2 min.	4 min.

Method

- Place the rice in the steam oven first.
- Set the first cooking duration: 14 minutes.
- After 14 minutes, place the tilapia in the steam oven.
- Set the second cooking duration: 2 minutes.
- After 2 minutes, place the broccoli in the steam oven.
- Set the third cooking duration: 4 minutes.

Sous-vide (vacuum) cooking

Always follow USDA guidelines on food safety.

This gentle cooking method allows food to be cooked slowly at a low, constant temperature in vacuum packaging.

With vacuum cooking, moisture does not evaporate and all nutrients and flavors are retained.

The result is flavorful and cooked evenly.

Only use food that is fresh and in good condition.

Ensure hygienic conditions and that food has not been out of the refrigerator too long, e.g. during transportation.

Use only heat-stable, boiling-resistant vacuum bags.

Do not cook food in the manufacturer's packaging, such as vacuum-packed frozen food. It is possible that an unsuitable vacuum bag was used.

Use the vacuum bag only once.

Vacuum-seal the food in a chamber system vacuum sealer only.

Sous-vide (vacuum) cooking

Important information on use

To obtain an optimum cooking result, observe the following information:

- Use fewer herbs and spices than for conventional cooking, since the influence on the taste of the food is more intense.
You can also prepare the food unseasoned and add seasonings after cooking.
 - The cooking duration reduces when salt, sugar, and liquids are added.
 - The food becomes firmer with the addition of acidic ingredients, such as lemon or vinegar.
 - Do not use alcohol or garlic, as an unpleasant taste may result.
 - Only use vacuum bags that match the size of the food. If the vacuum bag is too big, too much air may remain inside.
 - If you want to cook several foods in one vacuum bag, put the food in the bag one next to the other.
 - If you want to cook food in several vacuum bags at once, put the bags on the shelf one next to the other.
- Cooking durations will depend on the thickness of the food.
 - Keep the door closed during the cooking process. Opening the door extends the cooking process and can affect the cooking result.
 - Information on temperature and duration from sous-vide recipes cannot always be adopted 1:1. Adjust these settings according to the desired level of doneness.

Sous-vide (vacuum) cooking

Tips

- To shorten the preparation times, you can vacuum food 1–2 days before the cooking procedure. Store the vacuumed food in the refrigerator at a maximum of 41°F / 5°C. To maintain quality and taste, the food must be cooked after 2 days at the latest.
- Freeze liquids such as marinades before vacuum-sealing to prevent them from escaping from the vacuum bag.
- Fold the edges of the vacuum bag outwards for filling in order to obtain clean, perfect weld seams.
- If you do not want to eat the food directly after cooking, put it in an ice bath and then store it at a maximum of 41°F / 5°C.

In this way, you can maintain quality and taste while extending the life of the food.

Exception: Eat poultry immediately after cooking.

- After cooking, cut the vacuum bag on all sides to access the food better.
- Briefly fry meat and firm types of fish (such as salmon) before serving for a roasted aroma.

- Extra marinade can be used to prepare a sauce.
- Serve the food on preheated plates.

Sous-vide (vacuum) cooking

Method

- Rinse the food under cold water and dry it.
- Put the food in a vacuum bag and add spices or liquid if desired.
- Vacuum-seal the food in a chamber system vacuum sealer.
- For optimum cooking results, insert the rack on shelf level 2.
- Lay the vacuum-sealed food on the shelf (next to each other in the case of several bags).
- Select Operating Modes .
- Select Sous-vide .
- Adjust the recommended temperature, if necessary.
- Set the cooking duration. Any time between 1 minute and 10 hours can be set.
- Select additional settings if required (see "Operation: Steam cooking - Additional functions").
- Confirm with OK.

Possible causes for poor results

The vacuum bag has opened:

- The weld seam was not clean or stable enough and dissolved.
- The bag was damaged by a sharp bone.

The food has an unpleasant or strange taste:

- Incorrect storage of the food; the food was kept out of the refrigerator for too long.
- The food was contaminated with bacteria before it was vacuum sealed.
- Too much spice was used.
- The bag or weld seam were damaged.
- The vacuum was insufficient.
- The food was not immediately eaten or cooled after cooking.

Sous-vide (vacuum) cooking

Food	Added in advance		🌡️ [°F / °C]	🕒 [min]
	Sugar	Salt		
Fish				
Cod filet, 1" (2.5 cm) thick		x	130 / 54	35
Salmon filet, 1 1/4" (3 cm) thick		x	125 / 52	30
Monkfish filet		x	145 / 62	18
Pikeperch filet, 3/4" (2 cm) thick		x	130 / 55	30
Vegetables				
Cauliflower florets, medium to large		x	185 / 85	40
Squash in slices		x	185 / 85	15
Kohlrabi in slices		x	185 / 85	30
Asparagus, white, whole	x	x	185 / 85	22–27
Sweet potatoes in slices		x	185 / 85	18
Fruit				
Pineapple in slices	x		185 / 85	75
Apple in slices	x		175 / 80	20
Bananas, whole			145 / 62	10
Peaches, halved	x		145 / 62	25–30
Rhubarb pieces			167/75	13
Plums, halved	x		160 / 70	10–12
Miscellaneous				
Beans, white, soaked at a 1:2 ratio (beans to liquid)		x	195 / 90	240
Shrimp, peeled and deveined		x	135 / 56	19–21
Egg, whole			149 - 151 / 65–66	60
Scallops, removed from shell			125 / 52	25
Shallot, whole	x	x	185 / 85	45–60

🌡️ Temperature / 🕒 Cooking duration

Sous-vide (vacuum) cooking

Food	Added in advance		🌡️ [°F / °C]		🕒 [min]
	Sugar	Salt	Medium*	Well done*	
Meat					
Duck breast, whole		x	151 / 66	162 / 72	35
Rack of lamb			136 / 58	144 / 62	50
Beef tenderloin, 1 3/4" (4 cm) thick			133 / 56	142 / 61	120
Beef filet, 1" (2.5 cm) thick			133 / 56	–	120
Pork tenderloin, whole		x	145 / 63	153 / 67	60

🌡️ Temperature / 🕒 Cooking duration

* Degree of doneness

The "well done" degree of doneness has a higher core temperature than "medium," but is not cooked through in the traditional sense.

Sous-vide (vacuum) cooking

Reheating

Reheat brassicas (e.g., kohlrabi and cauliflower) only in combination with a sauce. Without sauce, an unpleasant cabbage-like taste and gray-brown color may develop.

Food with a short cooking time and food whose degree of cooking changes during reheating, e.g., fish, are fundamentally not suited for reheating.

Preparation

Place the cooked food into ice water for about an hour directly after cooking. The fast cooling prevents the food from continuing to cook. The optimum cooking condition is thus retained. Then store the food in the refrigerator at a maximum of 41°F / 5°C.

Please note that the quality of the food decreases the longer it is stored.

We recommend that you do not store the food in the refrigerator for longer than 5 days before reheating.

Settings

Operating Modes | Sous-vide 

Temperature: See the table

Time: See the table

Sous-vide (vacuum) cooking

Table for the reheating of food cooked with the sous-vide method

Food	🌡️ [°F / °C]		⌚ ² [min]
	Medium ¹	Well-done ¹	
Meat			
Rack of lamb	136 / 58	144 / 62	30
Beef filet steak, 1 3/4" (4 cm) thick	133 / 56	142 / 61	30
Beef rump steak, 1" (2.5 cm) thick	133 / 56	–	30
Pork tenderloin, whole	145 / 63	153 / 67	30
Vegetables			
Cauliflower florets, medium to large ³	185 / 85		15
Kohlrabi in slices ³	185 / 85		10
Fruit			
Pineapple in slices	185 / 85		10
Other food			
Beans, white, soaked at a 1:2 ratio (beans to liquid)	194 / 90		10
Shallot, whole	185 / 85		10

🌡️ Temperature / time ⌚

¹ Degree of doneness

The "done" degree of doneness has a higher core temperature than "medium," but is not cooked through in the classical sense.

² The times apply for food with a starting temperature about 41°F / 5°C (refrigerator temperature).

³ Reheat only cooked in sauce.

Special modes

Reheat

Always follow USDA guidelines on food safety.

To reheat food cooked with the sous-vide method, use the "Sous-vide" mode (see the "Sous-vide – Reheating" chapter).

The steam oven is very effective at reheating food gently, without drying it out or cooking it further. The food reheats evenly and does not need to be stirred during the reheating process.

You can reheat individual dishes or plated meals which have been prepared previously (e.g. meat, vegetables and potatoes).

Suitable containers

Small quantities can be reheated on a plate, larger quantities should be placed in a cooking pan.

Duration

10-15 minutes are usually sufficient for one plate of food. More than one plate will need a little longer.

If you are reheating several plated meals one after the other, the reheating time can be reduced by around 5 minutes for the second and subsequent plates as the oven will still be hot.

Moisture content

The more moist the food, the less moisture that needs to be added.

Tips

- Food does not need to be covered before it is reheated.
- Do not reheat large items whole. Divide it into portions and reheat these as plated meals.
- Compact items, such as stuffed peppers or roulades, should be cut in half.
- Please note that breaded items will not retain their crispness when they are reheated.
- Reheat sauces separately, except for dishes such as stew and casseroles where the sauce is part of the dish.

Settings

Special Modes  | Reheat

or

Operating Modes  | Combi Steam  |

Convection Bake 

Temperature: see chart

Moisture: see chart

Duration: see chart

Special modes

Food	🌡️ [°F / °C]	∆∆ [%]	🕒 [min]
Vegetables			
Carrots Cauliflower Kohlrabi Beans	250 / 120	70	8–10
Side dishes			
Pasta Rice Potatoes, halved lengthways	250 / 120	70	8–10
Dumplings Mashed potato	285 / 140	70	18–20
Meat and poultry			
Sliced meat, 1/2" / 1 1/2 cm thick Roulades, sliced Beef stew Lamb ragout Chicken cutlets Turkey cutlets, sliced	285 / 140	70	11–13
Fish			
Fish fillet Fish roulade, halved	285 / 140	70	10–12
Plated meals			
Spaghetti, tomato sauce Roast pork, potatoes and vegetables Stuffed peppers (halved), rice Chicken fricassee, rice Vegetable soup Creamy soup Clear soup Stew	250 / 120	70	10–12

🌡️ Temperature / ∆∆ Moisture / 🕒 Duration

Special modes

Defrost

Always follow USDA guidelines on food safety.

It is much quicker to defrost food in the steam oven than at room temperature.

Temperature

140°F / 60°C is the best temperature for defrosting.

Exception: 122°F / 50°C for minced meat and game

Before and after defrosting

Remove all packaging before defrosting.

Exceptions: Leave bread and baked goods in their packaging as otherwise they will absorb moisture and become soft.

Allow defrosted food to stand at room temperature after removing it from the oven. The standing time is necessary to allow the even distribution of heat.

Cooking pan

 Danger of salmonella poisoning. Do not use the liquid from defrosted meat or poultry. Dispose and wash the container, the sink and your hands.

Use a perforated container with a solid container underneath it when defrosting food which will drip, such as poultry. This way food will not be lying in defrosted liquid.

Foods which don't drip can be defrosted in a solid cooking pan.

Tips

- Fish does not need to be fully defrosted before cooking. Defrost so that the surface is sufficiently thawed to take herbs and seasoning. Depending on the thickness of the fish, 2–5 minutes should be enough.
- When defrosting food which has frozen together, e.g. berries, chops, fish filets etc. separate it about half-way through the defrosting time.
- Do not refreeze food once it has thawed.
- Defrost frozen ready meals according to the instructions on the packaging.

Settings

Special Modes  | Defrost
or

Operating Modes  | Steam Cooking 

Temperature: see chart

Defrosting duration: see chart

Special modes

Food to be defrosted	Quantity	🌡️ [°F / °C]	🕒 [min]	⌚ [min]
Fruit				
Apple sauce	1/2 lb / 250 g	140 / 60	20–25	10–15
Apple chunks	1/2 lb / 250 g	140 / 60	20–25	10–15
Apricots	1 lb / 500 g	140 / 60	25–28	15–20
Strawberries	10.6 oz / 300 g	140 / 60	8–10	10–12
Raspberries / Black currants	10.6 oz / 300 g	140 / 60	8	10–12
Cherries	5.3 oz / 150 g	140 / 60	15	10–15
Peaches	1 lb / 500 g	140 / 60	25–28	15–20
Plums	1/2 lb / 250 g	140 / 60	20–25	10–15
Gooseberries	1/2 lb / 250 g	140 / 60	20–22	10–15
Vegetables				
Frozen in a block	10.6 oz / 300 g	140 / 60	20–25	10–15
Fish				
Fish filets	14 oz / 400 g	140 / 60	15	10–15
Trout	1 lb / 500 g	140 / 60	15–18	10–15
Lobster	300 g/10.6 oz.	140 / 60	25–30	10–15
Shrimp	10.6 oz / 300 g	140 / 60	4–6	5
Ready meals				
Meat, vegetables, side dishes / stew / soup	17 oz / 480 g	140 / 60	20–25	10–15
Meat				
Roast meat, sliced	4.4-5.3 oz. / 125–150 g each	140 / 60	8–10	15–20
Ground meat	1/2 lb / 250 g	125 / 50	15–20	10–15
Ground meat	1 lb / 500 g	125 / 50	20–30	10–15
Stew	1 lb / 500 g	140 / 60	30–40	10–15
Stew	2 lbs / 1000 g	140 / 60	50–60	10–15
Liver	1/2 lb / 250 g	140 / 60	20–25	10–15
Cutlets / chops / sausage	28 oz / 800 g	140 / 60	25–35	15–20
Poultry				

Special modes

Food to be defrosted	Quantity	🌡️ [°F / °C]	🕒 [min]	⌚ [min]
Chicken	2 lbs / 1000 g	140 / 60	40	15-20
Chicken thighs	5.3 oz / 150 g	140 / 60	20-25	10-15
Chicken filet	1 lb / 500 g	140 / 60	25-30	10-15
Turkey drumsticks	1 lb / 500 g	140 / 60	40-45	10-15
Baked goods				
Puff pastries / Yeast baked goods	–	140 / 60	10-12	10-15
Cakes and cookies	14 oz / 400 g	140 / 60	15	10-15
Bread / Rolls				
Rolls	–	140 / 60	30	2
Rye bread, sliced	1/2 lb / 250 g	140 / 60	40	15
Whole grain bread, sliced	1/2 lb / 250 g	140 / 60	65	15
White bread, sliced	5.3 oz / 150 g	140 / 60	30	20

🌡️ Temperature / 🕒 Duration / ⌚ Standing time

Canning

Always follow USDA guidelines on food safety.

Only use unblemished, fresh produce which is in good condition.

Glass jars

Use clean glass jars and accessories and check them for any defects. Glass jars with twist off lids or glass lids with a rubber seal are suitable.

Make sure that all the glass jars are the same size so that bottling is carried out evenly.

After you have filled the jars with the bottled produce, clean the glass rims with a clean cloth and hot water and then seal the jars.

Fruit

Sort fruit carefully, rinse it briefly but thoroughly and allow it to drain. Take great care when cleaning soft fruit as it is very delicate.

Remove any peel, stalks, cores or pits. Cut up large fruit. For example, cut apples into slices.

If you are bottling fruit with pits (e.g. plums, apricots) without removing the pits, pierce the fruit several times with a fork or wooden skewer as otherwise it will burst.

Vegetables

Rinse, clean and cut up vegetables.

Vegetables should be blanched before bottling to help them retain their color (see "Blanching").

Fill volume

Fill the glass jars with produce up to a maximum of 1 1/4" (3 cm) below the rim. Do not pack down as this would damage the cell walls of the produce. Bang the jar gently on a cloth to help distribute the contents evenly.

Use a sugar solution for fruit and a salt or vinegar solution for vegetables.

Tips

- Make use of residual heat by leaving the jars in the oven for 30 minutes after it has switched off.
- Then cover the jars with a cloth and allow to cool for approx. 24 hours.

Method

- Place a perforated pan on the lowest shelf level.
- Place the jars (all the same size) in the perforated cooking pan. Ensure that they do not touch one another.

Settings

Special Modes  | Canning

or

Operating Modes  | Steam Cooking 

Special modes

Juicing

This appliance is ideal for extracting juice from soft, firm and hard fruit.

It is best to use overripe fruit, as the riper the fruit the greater the quantity of juice produced. Very ripe fruit will also produce a more intense flavor.

Preparation

Sort and rinse the fruit. Cut out any blemishes.

Remove the stalks from grapes and cherries as these are bitter. The stalks do not need to be removed from berries.

Cut larger fruit into chunks approx. 1" (2 cm) in size. The harder the fruit the smaller the pieces should be.

Tips

- Try experimenting with mild and tart flavors.
- The juice quantity and aroma are improved if sugar is added to the fruit and is allowed to soak in for several hours. We recommend $\frac{1}{4}$ – $\frac{1}{2}$ cup (50–100 g) sugar per 2 lbs (1 kg) of sweet fruit and $\frac{1}{2}$ – $\frac{3}{4}$ cup (100–150 g) sugar for 2 lbs (1 kg) tangy fruit.
- If you wish to bottle the juice rather than consume it straight away, while still hot pour it into clean bottles and seal immediately.

Method

- Put the prepared fruit (cleaned, washed, chopped etc.) into a perforated cooking pan.
- Place a solid container or the universal tray underneath to catch the juice.

Settings

Operating Modes | Steam Cooking 

Temperature: 210°F / 100°C

Duration: 40–70 minutes

Menu Cooking

You can cook up to three different types of food, e.g. fish with a side dish and vegetables.

The food can be selected in any order you like. The appliance will automatically sort them out in order of cooking duration required. The one with the longest duration goes in the oven first.

The Ready at and Start at functions are not available for "Menu Cooking."

Method

- Turn the steam oven on.
- Then place the drip tray / universal tray (depending on model) in the appliance.
- Select Special Modes  | Menu Cooking.
- Select the type of food.

Depending on the food, you will be asked about the size and the degree of doneness.



- Select or enter the values required and then confirm your selection with OK.
- Select Add food.
- Select the food you want and proceed in the same way as with the first ingredient.
- Repeat the procedure, if necessary, for the third ingredient.

After you have confirmed Start Menu Cooking, the display will tell you which food to put in the oven. At the end of the preheating phase, the display will show when the next food type is to be placed in the oven. When the time for the next food type to be placed in the oven is reached, the display will show the food type and the shelf runner. This process will be repeated for the third food type.

You can still cook food types not listed on the display together. See "Menu Cooking - Manually" for details on how to do this.

Special modes

Dehydrate

Only use the special application Dehydrate or the Combi Steam  | Convection Bake  mode to dry food so that moisture can be dissipated.

Method

- Cut the food into similar sized pieces.
- Place the pieces on the rack covered with baking paper.

Tip: Bananas and pineapple are not suitable for drying in a combi steam oven.

Settings

Special Modes  | Dehydrate

Temperature: see chart

Drying time: see chart

or

Operating Modes  | Combi Steam  | Convection Bake 

Temperature: see chart

Drying time: see chart

Moisture: 0 %

Food	🌡️ [°F / °C]	🕒 [h]
Apple, rings	160 / 70	6–8
Apricots, halved, pitted	140-160 / 60–70	10–12
Pears, sliced	160 / 70	7–9
Herbs	140 / 60	1.5–2.5
Mushrooms	160 / 70	3–5
Tomatoes, sliced	160 / 70	7–9
Citrus fruit, sliced	160 / 70	8–9
Plums, pitted	140-160 / 60–70	10–12

🌡️ Temperature / 🕒 Time (hours)

Making Yogurt

Always follow USDA guidelines on food safety.

To make yogurt, you will need either fresh live yogurt or yogurt culture, obtainable from health food stores.

Use natural yogurt with live culture and without additives. Do not use heat-treated yogurt.

The yogurt must be fresh (short storage time).

You can use either pasteurized or fresh whole milk. Pasteurized milk can be used without any further treatment. Fresh milk must first be heated to 195° F / 90° C (not boiled!) and then cooled down to 95° F / 35° C. Fresh milk will give a firmer yogurt than long-life milk.

The yogurt and milk should have the same percentage fat.

Do not move or shake the jars while the yogurt is thickening.

After preparing the yogurt, it must be immediately placed in the refrigerator to cool down.

The firmness, fat content and cultures used in the yogurt starter all affect the consistency of homemade yogurt. Not all yogurts are equally suitable as yogurt starters.

Possible causes for poor results

Yogurt is not set:

Incorrect storage of the yogurt starter, too much time out of the refrigerator, packaging was damaged, milk was insufficiently heated.

Liquid has not been removed:

Jars were moved, yogurt was not cooled down quickly enough.

Yogurt is grainy:

Milk was overheated or in poor condition, milk and starter yogurt not evenly stirred.

Tip: When using yogurt enzyme, yogurt can be made from a milk / cream mixture. Mix $\frac{3}{4}$ liter/3 cups milk with $\frac{1}{4}$ liter/1 cup cream.

Special modes

Method

- Mix ½ cup (100 g) yogurt with 4 cups (1 liter) of milk or make up the mixture with yogurt starter powder, following the instructions on the packaging.
- Pour the mixture into glass jars and seal them.
- Place the jars in a cooking pan. Ensure that they do not touch one another.
- Immediately after the yogurt has been made, place the jars in the refrigerator, taking care not to move them unnecessarily.

Settings

MasterChef Auto | Special | Make Yogurt

or

Operating Modes | Steam Cooking

Temperature: 104°F / 40°C

Duration: 5:00 hours

Proofing

Method

- Prepare the dough according to the recipe.
- Place the bowl in a perforated cooking pan or on the rack.

Settings

Special Modes | Proof

Duration: as per recipe instructions

or

Operating Modes | Combi Steam

Convection Bake

Temperature: 86°F / 30 C

Duration: as per recipe instructions

Moisture: 100 %

Dissolving Gelatine

Method

- **Gelatine sheets:** Completely cover the gelatine sheets with cold water and leave to soak for 5 minutes. Remove the gelatine sheets from the bowl and squeeze them out. Empty the bowl. Place the squeezed gelatine sheets back in the bowl.
- **Gelatine powder:** Place the gelatine powder in a bowl and add water according to the instructions on the packaging.
- Cover the bowl and place it in a perforated cooking pan.

Settings

MasterChef Auto | Special | Dissolve Gelatine

or

Operating Modes | Steam Cooking

Temperature: 195°F / 90°C

Duration: 1 minute

Melting Chocolate

You can use the steam oven for melting any type of chocolate.

Method

- Break the chocolate into small pieces. Leave chocolate cake covering in its packaging, and place in a perforated cooking pan.
- Place large quantities in a solid container and small quantities in a cup or a bowl.
- Cover the container or the dish with a lid or with foil that is resistant to temperatures up to 212°F / 100°C and to hot steam.
- Stir large quantities once during cooking.

Settings

MasterChef Auto | Special | Melt Chocolate

or

Operating Modes | Steam Cooking

Temperature: 150°F / 65 °C

Duration: 20 minutes

Special modes

Skimming Fruits and Vegetables

Method

- Cut a cross in the top of tomatoes, nectarines etc. This will allow the peel to be removed more easily.
- Place the food in a perforated pan, if cooking with steam or a universal tray, if using the grill.
- For almonds, it is important to plunge them into cold water as soon as they are taken out of the oven otherwise the skin cannot be removed.

Settings

Operating Modes | Maxi Broil

Level: 3

Duration: see chart

Food	🕒 [min]
Bell Peppers	10
Tomatoes	7

🕒 duration

Operating Modes | Steam Cooking

Temperature: 210°F / 100°C

Duration: see chart

Food	🕒 [min]
Apricots	1
Almonds	1
Nectarines	1
Bell Peppers	4
Peaches	1
Tomatoes	1

🕒 Duration

Preserving Apples

You can treat homegrown apples in the steam oven to increase the length of time for which you can store them.

Once treated, the apples will keep for 5 to 6 months when stored in a dry, cool and well-ventilated place. This method is only suitable for apples and not for other types of fruit.

Settings

MasterChef Auto | Fruit | Apples | Whole | Preserving

or

Operating Modes | Steam Cooking

Temperature: 125°F / 50°C

Preservation time: 5 minutes

Blanching

Blanch fruit and vegetables before freezing them. Blanching helps maintain the quality of the produce when it is frozen.

Blanching vegetables also helps them retain their original color.

Method

- Put the prepared vegetables (cleaned, washed, chopped etc.) into a perforated cooking pan.
- Once blanched, plunge the vegetables into ice cold water to cool them down quickly. Drain them well.

Settings

Special Modes | Blanch

or

Operating Modes | Steam Cooking

Temperature: 210°F / 100°C

Duration: 1 minute

Special modes

Sweating Onions

Sweating means cooking the onions in their own juices, with the addition of a little fat if necessary.

Method

- Cut the onions up into small pieces and place them in a solid cooking pan with a little butter.
- Cover the container or the dish with a lid or with foil that is resistant to temperatures up to 212°F / 100°C and to hot steam.

Settings

MasterChef Auto | Special | Steam Onions

or

Operating Modes | Steam Cooking

Temperature: 210°F / 100°C

Duration: 4 minutes

Rendering Fat

The bacon will not become brown.

Method

- Place the bacon (diced or rashers) in a solid cooking pan.
- Cover the container with a lid or with foil that is temperature resistant up to 212°F / 100°C and to steam.

Settings

MasterChef Auto | Special | Render Fat

or

Operating Modes | Steam Cooking

Temperature: 210°F / 100°C

Duration: 4 minutes

Sanitizing Cookware

The steam oven will sanitize baby bottles and other cookware. Check beforehand that the manufacturer guarantees all components are to be heat resistant to 212° F / 100 °C and also steam resistant follow manufacturers instructions.

Dismantle, clean and thoroughly rinse baby bottles. Reassemble the bottles only after they have completely dried. This prevents recontamination.

Method

- Place the individual parts on a rack or in a perforated cooking container, ensuring that they do not touch one another (on their sides or with the opening facing downwards). This will allow the steam to reach the parts from all sides.
- Place the rack or the container on the lowest shelf level.

Settings

Special Modes  | Sanitize Cookware
Duration: 1 minute to 10 hours

or

Operating Modes | Steam Cooking 
Temperature: 210°F / 100°C
Duration: 15 minutes

Heating damp towels

Method

- Moisten the towels and then roll them up.
- Place them beside one another in a perforated cooking pan.

Settings

MasterChef  | Special | Heat Damp Towels

or

Operating Modes | Steam Cooking 
Temperature: 160°F / 70°C
Duration: 2 minutes

Special modes

Decrystalize honey

Method

- Loosen the lid and place the jar of honey in a perforated cooking pan.
- Stir the honey once during the cooking procedure.

Settings

MasterChef Auto | Special | Decrystallize Honey

or

Operating Modes | Steam Cooking

Temperature: 140°F / 60°C

Duration: 90 minutes (irrespective of the size of jar or the amount of honey in the jar)

Pizza

Settings

Special Modes | Pizza

or

Operating Modes | Convection Bake

Temperature: 355-437°F / 180-225°C

Duration: 1-20 minutes

Tip: Use the rack lined with baking parchment

Making jam

Only use unblemished, fresh produce which is in good condition.

Glass jars

Only use sterilised jars with twist-off lids up to a maximum capacity of 1 cup / 250 ml.

After pouring in the jam, clean the outside of the rim of the jar with a cloth and hot water.

Preparation

Sort fruit carefully, rinse it briefly but thoroughly and allow it to drain. Take great care when cleaning soft fruit as it is very delicate and squashes easily. Remove any stalks, cores or pits.

Purée the fruit as otherwise the preserve will not set. Add jam sugar to the fruit (according to packet instructions) and stir well.

For sweet fruit and berries you should also add some citric acid.

Method

- Fill jars maximum 2/3 full.
- Place the open jars in a perforated cooking pan or on the rack.
- At the end of the program take the jars out of the steam oven using oven gloves. Leave them to stand for 1 - 2 minutes before sealing them with twist off lids and then leave them to cool.

Settings

Operating Modes | Combi Steam

Convection Bake

Temperature: 300°F / 150°C

Duration: 35 minutes

Moisture: 0%

Special modes

Sabbath Program

This mode is designed for religious observance.

The program operates with Surround  and cannot be changed.

The program will only start once the door is opened and closed:

- The steam oven will heat up to the temperature you have set and will maintain this temperature for a maximum of 72 hours.
- Sabbath Program appears in the display constantly.
- The time of day is turned off.
- The interior lighting does not come on, even when the door is opened.

If the Lighting | On setting has been selected, the lighting remains switched on when the Sabbath program has been selected and will stay on for the duration of the program.

The Sabbath program cannot be selected if an alarm has been set or a timer is counting down.

Method

- Select Special Modes .
- Select Sabbath Program.
- Set the required temperature.
- Select Start.

Sabbath Program and the set temperature will appear in the display.

The steam oven is ready for use.

- Open the door to start the program.
- Put the food in the oven.
- Close the door.

The program will start after approximately 5 minutes.

Once the "Sabbath" program has started it cannot be changed or saved as a Favorites.

To end the program early:

- Turn the steam oven off.

How it works

The metal tip of the roast probe is inserted into the food. There is a temperature sensor in the metal tip which measures the core temperature of the food during cooking.

The core temperature set will depend on how well cooked you want your meat to be and on the type of meat. The temperature can be set between 86 and 210°F / 30 and 99°C.

The cooking duration will depend on a number of different factors. The higher the temperature in the oven compartment and the humidity, where applicable and the thinner the meat, the quicker the set core temperature will be reached.

The cooking process will finish automatically when the core temperature in the meat reaches the value set for the roast probe. Exception: In Combi Steam  mode or with user programs, another cooking stage, e.g., browning the meat, may be required.











Damage to roast probe by incorrect use!

If you are not using the roast probe remove it from the oven when cooking.

It is only protected from overheating when it is plugged in.

When to use the roast probe

The roast probe can be used in the following operating modes:

- Combi Steam  | Convection Bake 
- Combi Steam  | Surround 
- Convection Bake 
- Convection Broil 
- Surround 
- Intensive 
- Humidity Plus 
- Steam Cooking 
- Special Modes  | Reheat

Roast probe

Important notes regarding the roast probe

The handle and cord of the roast probe must not touch the browning / broiling element during cooking.

Risk of breakage!

Do not use the roast probe to lift or carry the food.

The metal tip of the roast probe must be fully inserted into the center of the food.

Do not let the metal tip touch any bones, and do not insert it into a particularly fatty area of the meat. Heavily marbled areas and bones can cause cooking to end prematurely.

If the meat is very heavily marbled with fat, select the highest core temperature given in the roasting chart.

When using roasting bags, insert the probe through the bag into the center of the meat.

You can also place the meat, with the roast probe inserted, inside the bag. Follow the roasting bag manufacturer's instructions.

If wrapping meat in aluminum foil, the roast probe must be inserted through the foil to the center of the meat.

Method

- Prepare the food.
- Insert the metal tip of the roast probe fully into the food.
- Place the food in the oven.

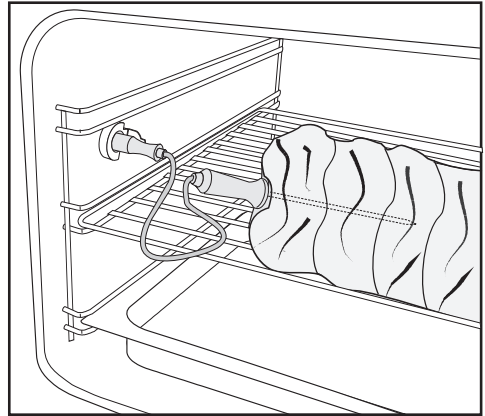

- Open the connection socket for the roast probe and insert the plug of the roast probe into the socket until you feel it engage.
- Select the desired mode.
- Alter the recommended and/or core temperature if necessary.

After the cooking process



Burn hazard!

The roast probe can get hot.

- Before taking the food out of the oven, carefully remove the roast probe plug from the connection socket.

Tips

- If you are cooking several pieces of meat together, the roast probe should be inserted into the largest piece of meat.
- If the food is not cooked sufficiently when the core temperature is reached, insert the roast probe into another place or increase the core temperature and repeat the program.

Meat	 [°F / °C]
Veal	165–175 / 75–80
Smoked pork	165 / 75
Leg of lamb	175–185 / 80–85
Saddle of lamb	160–170 / 70–75
Saddle of venison / hare	150–170 / 65–75
Top or bottom round roast	175–195 / 80–90
Beef tenderloin / Sirloin	
rare	115 / 45
medium	130 / 55
well done	165 / 75
Pork / blade roast	175–195 / 80–90
Pork tenderloin / chop	165 / 75
Game / rump cut	175–195 / 80–90

 Core temperature

Roast

Always follow USDA guidelines on food safety.

Roasting tips





- Insert the grease filter into the back wall.

Frozen meat must be defrosted before it is cooked as it would dry out.

- Always defrost meat before roasting.
- Remove skin and sinew before roasting.
- Season the meat to taste and dot with butter, or in the case of game, bard with rashers of streaky bacon.

Tip: Game can be marinated overnight e.g. in buttermilk, to tenderize it.

- If you are cooking several pieces of meat together, select pieces that are similar in size.
- Roast meat on the rack above the universal tray. The cooking liquids will collect in the tray and can then be used to make a gravy or sauce.
- Allow a standing time of approx. 10 minutes after the end of cooking so that the cooking liquids are evenly distributed.

We recommend the Combi Steam  | Convection Bake , and Combi Steam  | Surround  modes for roasting.

If you wish to use other modes, you can enter your cooking stages as a user program (see "User programs").

Combi Steam

The lower the temperature in the oven compartment, the longer the cooking process and the more tender the result.

Lean meat

The addition of steam prevents the surface of lean meat from drying out. Excellent results can be achieved when using 5 cooking stages for the cooking process

- Cooking stage 1: the oven compartment and the rack above the universal tray are pre-heated.
- Cooking stage 2: the meat is browned.
- Cooking stage 3: adjust the temperature so that it is suitable for cooking the meat so that it is tender.
- Cooking stage 4: cook until tender.
- Cooking stage 5: continue cooking to the required level.

Fatty meat with crispy skin

- Cooking stage 1: use a high temperature to render the fat and brown the skin.
- Cooking stage 2: reduce the temperature and increase the moisture
- Cooking stage 3: increase the temperature for crispy skin.

Braised dishes

- Cooking stage 1: preheat the oven with the rack above the universal tray.
- Cooking stage 2: the meat is browned.
- Cooking stage 3: braise the meat at a temperature of 210°F / 100 °C with 84% moisture.

Poultry

- Cooking stage 1: use a high temperature and a high moisture level to render the fat.
- Cooking stage 2: lower the temperature.
- Cooking stage 3: increase the temperature and reduce humidity to dry out and crisp the skin.

For more information about relevant settings, please refer to the following roasting chart.

Roast















































Roasting chart

Always follow USDA guidelines on food safety.

The times and temperatures given in the tables are recommendations only.

Type of meat	Stage	Operating mode	🌡️ [°F / °C]	📊 [%]	⌚ [min]	🔌 [°F / °C]
Poultry						
Duck up to 4 lbs / 2 kg, stuffed	1		375/190	40	20	–
	2		210/100	80	140	–
	3		375/190	–	23	–
Duck up to 4 lbs / 2 kg, un-stuffed	1		375/190	40	20	–
	2		210/100	80	100	–
	3		375/190	–	23	–
Duck breast, medium	1		Level 3	0	15	–
	2		85/30	0	20	–
	3		Level 3	0	7–13	–
Duck breast, well-done	1		Level 3	0	15	–
	2		85/30	0	20	–
	3		Level 3	0	7–13	–
	4		85/30	0	5	–
Goose, approx. 9 lbs / 4.5 kg	1		375/190	40	30	–
	2		210/100	80	270	–
	3		375/190	–	23	–
Chicken, whole	1		435/225	0	20	–
	2		300/150	55	60	–
	3		Level 3	0	2–12	–
Chicken thighs	1		395/200	95	30–25	–
	2		440/225	0	13–18	–
	3		Level 3	0	0–7	–
Turkey roulade, stuffed/un-stuffed	1		375/190	40	20	–
	2		285/140	75	100	–
	3		395/200	–	4–8	–
Turkey breast	1		340/170	65	85	–
	2		Level 3	–	0–9	–























































Roast

Type of meat	Stage	Operating mode	 [°F / °C]	 [%]	 [min]	 [°F / °C]
Veal						
Tenderloin (Roast)						
rare	–		347/175	–	–	115/45
medium	–		329/165	–	–	130/55
well done	–		320/160	–	–	165/75
Tenderloin (Roast with moisture)						
Rare*	1	 	Level 3	0	10	–
	2	 	Level 3	0	8	–
	3	 	140/60	0	30	–
	4	 	140/60	49	30	–
Medium*	1	 	Level 3	0	10	–
	2	 	Level 3	0	10	–
	3	 	210/100	0	20	–
	4	 	149/65	49	60	–
	5	 	158/70	51	60	–
Tenderloin (Roast with moisture)						
Well done*	1	 	Level 3	0	10	–
	2	 	Level 3	0	10	–
	3	 	210/100	0	20	–
	4	 	150/65	49	60	–
	5	 	195/90	68	50	–
	6		395/200	–	5	–
Saddle (Roast with moisture)						
Well done*	1	 	Level 3	0	10	–
	2	 	Level 3	0	10	–
	3	 	210/100	0	20	–
	4	 	150/65	49	60	–
	5	 	195/90	68	80	–
	6		395/200	–	5	–

Roast

Type of meat	Stage	Operating mode	🌡️ [°F / °C]	⊞ [%]	🕒 [min]	🔌 [°F / °C]
Ham hocks	1		210 / 100	84	155	–
	2		375 / 190	–	17	–
Braised meat*	1		Level 3	0	10	–
	2		Level 3	0	10	–
	3		100	84	165	–
Lamb						
Leg of lamb	1		Level 3	–	18	–
	2		210 / 100	57	190	–
Loin / Crown Medium*	1		Level 3	–	10	–
	2		Level 3	–	8	–
	3		85 / 30	0	30	–
	4		165 / 75	47	40	–
Well done*	1		Level 3	–	10	–
	2		Level 3	–	10	–
	3		85 / 30	0	30	–
	4		210 / 75	57	100	–
Pork						
Tenderloin	–		395 / 200	–	–	165 / 75
Smoked pork	1		395 / 200	0	30	–
	2		265 / 130	100	–	75
Crispy pork	1		225	54	40	–
	2		100	84	120	–
	3		165–185	–	20–25	–
Pork loin	1		355 / 180	50	30	–
	2		265 / 130	30	–	75
Beef						
Tenderloin (Roast)						
rare	–		345 / 175	–	–	115 / 45
medium	–		340 / 170	–	–	130 / 55
well done	–		330 / 165	–	–	165 / 75

Roast

Type of meat	Stage	Operating mode	 [°F / °C]	 [%]	 [min]	 [°F / °C]
Tenderloin (Roast with moisture)						
Rare*	1	 	Level 3	0	10	–
	2	 	Level 3	0	10	–
	3	 	140/60	0	30	–
	4	 	140/60	49	30	–
Medium*	1	 	Level 3	0	10	–
	2	 	Level 3	0	10	–
	3	 	210/100	0	20	–
	4	 	149/65	49	60	–
	5	 	158/70	51	60	–
Tenderloin (Roast with moisture)						
Well done*	1	 	Level 3	0	10	–
	2	 	Level 3	0	10	–
	3	 	210/100	0	20	–
	4	 	150/65	49	60	–
	5	 	195/90	68	105	–
	6	 	395/200	–	8	–
Sirloin (Roast)						
rare	–		345/175	–	–	115/45
medium	–		338/170	–	–	130/55
well done	–		330/165	–	–	165/75
Tenderloin (Roast with moisture)						
Rare*	1	 	Level 3	0	10	–
	2	 	Level 3	0	10	–
	3	 	140/60	0	30	–
	4	 	140/60	49	30	–
Medium*	1	 	Level 3	0	10	–
	2	 	Level 3	0	10	–
	3	 	210/100	0	20	–
	4	 	149/65	49	60	–
	5	 	158/70	51	60	–

Roast

Type of meat	Stage	Operating mode	🌡️ [°F / °C]	💧 [%]	🕒 [min]	🍖 [°F / °C]
Well done*	1		Level 3	0	10	–
	2		Level 3	0	10	–
	3		210/100	0	20	–
	4		150/65	49	60	–
	5		195/90	68	135	–
	6		395/200	–	8	–
Roulades**	1		Level 3	0	10	–
	2		Level 3	0	10	–
	3		210/100	84	120	–
Pot roast**	1		Level 3	0	10	–
	2		Level 3	0	10	–
	3		210/100	84	205	–
Game						
Venison saddle						
Medium*	1		Level 3	–	10	–
	2		Level 3	–	7	–
	3		85/30	0	30	–
	4		165/75	52	40	–
Well done*	1		Level 3	–	10	–
	2		Level 3	–	13	–
	3		85/30	0	30	–
	4		210/100	47	107	–

🌡️ Temperature/Broil level / 💧 Moisture / 🕒 Duration / 🍖 Core temperature

Combi Steam Convection Bake / Combi Steam Maxi Broil / Combi Steam Surround / Maxi Broil / Convection Broil

* In stage one please place the universal tray on shelf level 1 and the rack on shelf level 2 (except with rack of lamb where the rack is placed **on** the universal tray on shelf level 1) without food on it and pre-heat the oven.
Place the meat on the pre-heated rack at the beginning of stage 2.

** * In stage one, place the universal tray on shelf level 2 without food on it and pre-heat the oven. Place the meat on the pre-heated tray at the beginning of stage 2.

Eating food which has been cooked correctly is important for good health.

Only bake cakes, pizza, french fries, etc. until they are golden brown. Do not overcook them.

Convection Bake

For baking on several levels at the same time. The fan distributes the heat evenly throughout the cavity for a consistent baking temperature.

- When using Surround, reduce the temperatures given for Convection Bake by about 20°F/20°C.

Surround

Heat is used from both the upper and lower heating elements to create perfect results of all baking recipes.

- Use only one shelf level for baking.
- Place tray bakes on the middle shelf.
- If using an older recipe or cookbook, set the oven temperature 10°F/10°C lower than that recommended. This will not change cooking durations.

Browning

For a perfectly browned topping, for example when making a gratin or browning the top of a casserole..

Bake

Use this at the end of the baking time to brown the bottom of the food.

Humidity Plus

For creamed mixtures, choux pastry and deep frozen pretzels.

Intensive Bake

For baking cakes with a moist topping, e.g. cheese cake, fresh fruit cakes, quiche and flans. Also suitable for items such as pizza without the need to pre-bake the base.

- Bake on the lowest shelf level.

Combi Steam

The gleaming finish on bread, rolls and puff pastry is achieved by adding steam (maximum moisture, low temperature) in cooking stage 1. Browning is achieved using a high moisture level and a high temperature. The drying-out phase takes place with low moisture and a high temperature.

Bake

Baking tips

Grease filter

- Remove the grease filter from the back wall. Otherwise results can be uneven.

Bakeware

- Dark-colored bakeware is best for baking. It conducts the heat more swiftly to the mixture. Shiny metal bakeware reflects heat.

Cakes baked in shiny metal bakeware take longer to bake.

- Bake cakes in rectangular bakeware with the longer side across the width of the oven compartment for optimum heat distribution and even results.
- With MasterChef programs, use the bakeware recommended in the cookbook.

Universal tray

Because of its PerfectClean anti-stick surface, the universal tray does not need to be greased for baking.

Shelf level

- When baking cakes with a moist topping only bake on one level.
- Use a maximum of two shelf levels at once. If you want to bake on two shelf levels at the same time, use the bottom and middle level.

Parchment paper

Parchment paper is only necessary when baking:

- Anything with a high salt content (e.g. pretzels, bread sticks), because sodium can damage the PerfectClean surface
- Meringues or dishes with a high egg white content, because they are more likely to stick
- Puff pastry

Frozen food

- When baking deep frozen products such as chips, croquettes, cakes, pizza and baguettes, use the lowest temperature quoted on the manufacturer's packaging.
- Cook frozen goods such as cakes, pizza or baguettes on a layer of baking parchment placed on the rack.

Baking large frozen items on the baking tray or the universal tray can cause the metal to distort to such an extent that the tray cannot be taken out of the oven.









































- Small items of frozen food such as oven chips or potato croquettes can be cooked on the universal tray. Place them on baking parchment and turn several times during cooking.

Notes regarding the baking chart

- As a general rule, select the lower temperature given in the chart.
- Do not set a temperature higher than that recommended. Increasing the temperature may reduce the baking duration, but will lead to uneven browning, and unsatisfactory cooking results.
- Check if the food is cooked at the end of the shortest duration quoted. To check if a cake is ready, insert a wooden skewer into the center. It is ready if the skewer comes out clean, without dough or crumbs sticking to it.

Bake

Baking chart





Baked good	Stage	Operating mode	🔥 [F / °C]	ΔΔ [%]	⌚ min
Sponge					
Baking tray	–		300-355 / 150-180	–	25
Springform pan	–		320-340 / 160-170	–	25-35
Puff pastry					
Filled	1	 	210/100	100	7
	2	 	375-410/190	90	10
	3	 	–210	75	5
	4	 	375-410/190 –210 375-410/190 –210	0	6
Small pastry*	–		355/180	–	15
Choux pastry					
Cream puffs / Éclairs	–	 	300-365/150 –185	0	50
Yeast dough					
Bagels	1	 	210/100	100	10
	2	 	395/200	0	24
Baguettes, spelt bread	1	 	105/40	100	8
	2	 	125/50	100	4
	3	 	410/210	50	6
	4	 	355-410/180 –210	0	30
Butter Cake	1	 	320/160	90	15
	2	 	250-330/120 –165	0	10
Croissants	1	 	195/90	100	2
	2	 	320/160	90	10
	3	 	320-410/160 –190	0	27
Triple grain bread	1	 	85/30	100	15
	2	 	300/150	50	10
	3	 	300/150	0	100

Baked good	Stage	Operating mode	🌡️ [F / °C]	ΔΔ [%]	⌚ min
Flat bread	1		105/40	100	10
	2		125/50	100	2
	3		410/210	0	6
	4		310-375/155 -190	0	25
Braided loaf	1		105/40	100	8
	2		125/50	100	2
	3		395/200	50	10
	4		320-395/160 -200	0	12
White bread in rectangular pan	1		105/40	100	8
	2		125/50	100	4
	3		410/210	50	6
	4		430/220	0	25-50
Herb rolls	1		310/155	90	9
	2		395/200	0	15-25
Multigrain rolls	1		310/155	90	9
	2		395/210	0	20-30
Pizza	-		350-400 / 175-205	-	35
Braided Swiss loaf	1		195/90	100	6
	2		340-410/170 -210	50	45
Stollen	1		300/150	100	30
	2		265-320/130 -160	0	30
Streusel Cake	1		85/30	100	30
	2		320/160	90	25
	3		265-355/130 -180	0	10
Sweet rolls	1		105/40	100	8
	2		125/50	100	2
	3		395/200	50	10
	4		395/200	0	8-13
Whole grain bread	1		105/40	100	8
	2		125/50	100	4
	3		410/210	50	6
	4		375-420/190 -215	0	30
White bread	1		105/40	100	8
	2		125/50	100	4
	3		410/210	50	6
	4		340-410/170 -210	0	30

Bake

Baked good	Stage	Operating mode	🌡️ [F / °C]	ΔΔ [%]	⌚ min
White rolls	1		310/155	90	9
	2		395/200	0	20–30
Mixed wheat grain bread	1		105/40	100	8
	2		125/50	100	4
	3		410/210	50	6
	4		355-430/180-220	0	30
Onion tart	–		375/190	–	25–35
Short dough pastry					
Cookies	1		365/185	50	6
	2		365/185	0	10–15
Cakes with a dry topping	–		395/200	85	35
Cakes with a moist topping*	1		410/210	0	15
	2		375/190	0	20–30
Slice with topping	–		340-375/170-190	–	35–45
Quark dough					
Sweet rolls	1		125/50	100	5
	2		330/165	50	5
	3		330/165	0	14–26
Pizza	–		310-365/155-185	–	30
Baking tray	–		320-355/160-180	–	45–55
Batter					
Cake pan	–		340-375/170-190	–	55
Tray cake with fruit topping	–		340-375/170-190	–	40
Cookies	–		300-375 / 150-190	95	25
Pyramid cakes	–		Level 3	–	2–3**
Sourdough					
Rye mix bread	1		410/210	50	5
	2		375-410/190-210	0	50

Bake

Baked good	Stage	Operating mode	🌡️ [F / °C]	💧 [%]	🕒 min
Rye bread	1		410 / 210	60	6
	2		410 / 210	0	6
	3		310-340 / 155-170	0	60
Strudel					
Apple strudel	1		85/30	90	7
	2		375/190	0	35-60

🌡️ Temperature/Broil level / 💧 Moisture / 🕒 Duration

  Combi Steam Convection Bake /   Combi Steam Surround /

 Surround /  Convection Bake /  Intensive Bake /  Humidity Plus /  Maxi Broil





* Pre-heat the oven with nothing in it.

** Per layer

Broil

 Burn hazard!

The appliance door must remain shut during broiling, as otherwise the controls will get hot.

The roast probe cannot be used with the Maxi Broil , Broil , and Combi Steam  | Maxi Broil  modes.

Maxi Broil

This function gives excellent browning and searing results. Use this function for chops, ribs, large quantities of meat and for browning large dishes.

Broil

This function is excellent for broiling or searing small quantities. Use this function for chops, ribs, small quantities of meat and for browning small dishes.

Convection Broil

For broiling thicker items, e.g. poultry or roulades.

Broiling tips









- Place the food on the rack on top of universal tray.
- When broiling fish, place the fish on a piece of baking paper cut to size.
- Place the food in the steam oven without pre-heating. Pre-heating the steam oven is not necessary when broiling.
- Broil thick items, e.g. half a chicken, in the middle and thin items, e.g. steak, on the top shelf level.
- Turn the food after $\frac{2}{3}$ of the cooking time has elapsed. Fish does not need to be turned.

Tips

- Marinate or add a little oil if necessary to lean meat. Do not use other types of fat as they can burn and cause smoke.
- Make diagonal cuts in sausage before broiling.
- It is best to broil food of a similar thickness at the same time so that the broiling time for each item does not vary too greatly.
- To broil thicker pieces of food more gradually after an initial high temperature, continue broiling at a lower temperature setting or use a lower shelf runner to allow the food to cook through to the center.

Broil

Broiling table

Broiled food	Operating mode	🌡️ [F / °C]	💧 [%]	🕒 min
Fish				
Trout		Level 3	–	25–30
Salmon		355/180	–	35
Mackerel		Level 3	–	25
Meat / sausages				
Hamburgers		Level 3	–	20
Sausage fresh / pre-cooked		Level 3	–	15–20
Miscellaneous				
Toast		Level 3	–	5–8
Toast with toppings		Level 3	–	8–15
Corn on the cob		Level 3	30	23

🌡️ Temperature/Broil level / 💧 Moisture / 🕒 Duration

 Maxi Broil /  Convection Broil /  Combi Steam Maxi Broil

Accessing the "Settings" menu

From the main menu.

- Select  Settings.

The settings can now be checked or changed.

Settings cannot be altered while a cooking program is in progress.

Changing and saving settings

- Select  Settings.
- Swipe across the screen until the desired setting appears, then touch it to select.



The settings which are currently selected will have a colored frame around them.

- Swipe across the screen until the desired option appears, then touch it to select it.
- Confirm with *OK*.

The setting is now saved.

Settings

Settings overview

Option	Available settings
Language 	... / deutsch / english / ... Country
Time	Display On / Off * / Night Dimming Clock Type Analog * / Digital Clock Format 24 h * / 12 h (am/pm) Set
Date	
Lighting	On / On for 15 seconds *
Start Screen	Main Menu Operating Modes MasterChef Special Modes MyMiele Favorites
Brightness	
Volume	Buzzer tones Keypad tone Welcome Melody On * / Off
Units of Measurement	Weight g * / lb / lb/oz Temperature °C * / °F
Keeping Warm	On / Off *
Automatic Rinse	On * / Off
Steam Reduction	On * / Off
Recommended temperatures	
Safety	System Lock  On / Off * Sensor Lock On / Off *

Option	Available settings
Water hardness	Soft Medium Hard *
Showroom Program	Demo Mode On / Off *
Factory Default	Settings Favorites Recommended temperatures MyMiele



* Factory default

Settings

Language

The desired country and language can be set.

After selecting and confirming your choice, the language selected will appear in the display.



Tip: If you accidentally select a language you do not understand, select  Settings and use the  symbol to return to the Language  submenu.

Time of day



Display

Select how you would like the time of day to show in the display when the steam oven is switched off:

- On

The time of day always appears in the display. You can switch the lighting  on and off or use the alarm + timer  functions as well as open and close the control panel  by touching the relevant sensor.

- Off

The display is switched off to save energy. The steam oven has to be switched on before you can use it. This also applies to using the oven interior lighting , the alarm + timer  functions as well as opening and closing the control panel .

- Night Dimming

To save energy, the time is only visible in the display between 5:00 am and 11:00 pm. The rest of the time it is not visible.

Display

The time of day can be displayed in Analog (in the form of a clock face) or Digital (h:min). With the digital display, the date is also shown.

Clock format

You can select the clock format for the time of day:

- 24 h

The time of day is shown in 24-hour clock format.

- 12 h (am/pm)

The time of day is shown in 12-hour clock format.

Setting the time

Set the hours and the minutes.

If there is an interruption to the power supply, the current time of day will reappear once power has been restored. The time is stored in memory for about 200 hours.

Synchronize

This menu option only appears if you are connected to the Miele@home system (see separate instructions).

Date

Set the date.

When the steam oven is turned off, the date will only appear on the display if the Time | Clock Type | Digital is selected.

Lighting

- On
The interior lighting is switched on during the entire cooking period.
- On for 15 seconds
The oven lighting switches off 15 seconds after a program starts. Touching  switches it on for another 15 seconds.

Start screen

The main menu will appear in the display when the oven is turned on. You can change this default setting so that, for instance, the oven modes or MyMiele settings appear in the display.

Brightness

The display brightness is represented by a bar with seven segments.



- Select **Darker** or **Lighter** to change the brightness of the display.

Volume

Buzzer tones

The volume is represented by a bar with seven segments.



Maximum volume is selected when all segments are filled. If none of the segments are filled, the volume is switched off.

- Select **Quieter** or **Louder**, to adjust the volume.
- Select **On** or **Off** to switch the buzzer tones on or off.

Keypad tone

The volume is represented by a bar with seven segments.



Maximum volume is selected when all segments are filled. If none of the segments are filled, the volume is switched off.

- Select **Quieter** or **Louder**, to adjust the volume.
- Select **On** or **Off**, to switch the keypad tone on or off.

Welcome melody

You can turn the welcome melody on or off. It sounds when the On / Off button  is touched.

Settings

Units of measurement

Weight



- g
The weight of food in MasterChef programs is shown in grams.
- lb
The weight of food in MasterChef programs is shown in pounds.
- lb/oz
The weight of food in MasterChef programs is shown in pounds/ounces.

Temperature

- °C
The temperature is displayed in Celsius.
- °F
The temperature is displayed Fahrenheit.

Keeping Warm

Please note that delicate food, especially fish, can continue cooking while being kept warm.

- On
The keeping warm function is activated as standard with Steam Cooking  if a temperature above approx. 176°F / 80°C is selected. If food is not removed from the oven at the end of a program, the keeping warm function will automatically start after approx. 5 minutes. Keeping Warm will appear in the display and the food will be kept warm for approx. 15 minutes at a temperature of 158°F / 70°C. The keeping warm function is canceled when the display or  is touched or the door is opened.
- Off
The "Keeping Warm" function is deactivated.

Automatic rinsing

Following a cooking program with steam, **Appliance rinsing** will appear in the display after the steam oven has been switched off.

Any remaining food deposits are flushed out of the system.

You can activate or deactivate the automatic rinsing process.

Steam reduction

– On

If you cook at a temperature from approx. 175°F / 80°C (Steam cooking) or 175-210°F / 80-100°C and 100% moisture (Combi Steam), the steam reduction function switches on automatically at the end of the cooking program. This reduces the amount of steam which escapes from the appliance when the door is opened at the end of the cooking duration. **Steam Reduction** will appear in the display in addition to **Program Finished**.

– Off

If steam reduction is switched off the **Keeping Warm** function is also automatically switched off. If steam reduction is switched off a large amount of steam will escape when the door is opened.

Recommended temperatures

If you often cook with temperatures that differ from the default, it makes sense to change the recommended temperatures.

Once an option has been selected, the operating mode or special application will appear together with the recommended temperature.

- Select the operating mode / special application you want.
- Change the recommended temperature.
- Confirm with OK.

Safety

System lock

The system lock prevents the appliance being turned on by mistake.

The alarm and timer can still be set when the system lock is active.

The system lock will remain activated even after a power failure.

– On

The system lock is active. If you want to use the steam oven, press the  symbol for at least 6 seconds.

– Off

The system lock is not active. You can use the steam oven as normal.

Settings

Sensor lock

The sensor lock prevents a cooking process from being switched off or changed while it is running. Once activated, the sensors are locked a few seconds after a program has started.

– On

The sensor lock is active. Press the  symbol for at least 6 seconds to use the sensors again. The sensor lock is then deactivated for a short period.

– Off

The sensor lock is deactivated. All sensors react to touch as normal.

Water hardness

The steam oven is factory set for Hard water. It must be adjusted local water hardness to ensure trouble-free operation and to ensure that descaling is carried out at the correct interval. The harder the water, the more often it will need to be descaled.

– Soft

< 8.7 °gr/gal, < 1.5 mmol/l

– Medium

8.7 - 14.6 °gr/gal, 1.5 - 2.5 mmol/l

– Hard

> 14.6 °gr/gal, > 2.5 mmol/l

Showroom program

This mode enables the oven to be demonstrated in showrooms without heating up. It should not be set for domestic use.

Demo mode

If demo mode is activated Demo Mode active. The appliance will not heat up **will** appear when the steam oven is turned on.

– On

Press OK for at least 4 seconds to activate demo mode.

– Off

Press OK for at least 4 seconds to deactivate demo mode. The steam oven can then be used as normal.

Factory default settings

– Settings

Any settings that have been altered will be reset to the factory default setting.

– Favorites

All Favorites will be deleted.

– Recommended temperatures

Any recommended temperatures that have been changed will reset to the factory default settings.

– MyMiele

All MyMiele entries will be deleted.

Cleaning and care

Important information on cleaning and care



Risk of injury!

The steam from a steam cleaner could reach electrical components and cause a short circuit.

Do not use a steam cleaner to clean the steam oven.

All surfaces can become discolored or damaged if unsuitable cleaning agents are used. The front of the oven, in particular, will be damaged by oven cleaners.

All surfaces are susceptible to scratching. Scratches on glass surfaces may cause a breakage.

Immediately remove any residues left by cleaning agents.

Stubborn soiling could damage the steam oven in certain circumstances.

Once the oven has cooled clean the oven, the inside of the door and the door seal. Waiting too long to clean the oven will make it much more difficult to clean.

Do not use commercial cleaning agents. Only use agents designed for domestic use.

Do not use cleaning agents or liquid dish soap containing aliphatic hydrocarbons as these could cause the seals to swell.

Allow the appliance to cool down to a safe temperature before cleaning.

- The appliance and accessories should be cleaned and dried thoroughly after each use.
- Leave the appliance door open until the oven interior is completely dry.

If the appliance is not going to be used for a longer period of time, e.g. while on vacation, it should be thoroughly cleaned and dried beforehand to prevent the build-up of odors, etc. Leave the door open afterwards.

To better maintain your appliance avoid the following:

To avoid damaging surfaces when cleaning, do not use:

- Cleaners containing soda, ammonia, thinners, or chlorides
- Descaling agents
- Abrasive cleaning agents (e.g., powder or cream cleansers, pumice stones)
- Solvent-based cleaners
- Stainless steel cleaners
- Dishwasher cleaners
- Ceramic cooktop cleaners
- Hard, abrasive brushes or sponges (e.g. pot scrubbers or scrub sponges, sponges which have previously been used with abrasive cleaning agents)
- Eraser sponges
- Sharp metal scrapers
- Steel wool
- Stainless steel spiral pads
- Spot cleaners
- Oven sprays

Glass cleaners **may be used** to clean the exterior. However **do not** allow them to sit or "puddle", this can cause damage to the surface. **Remove the cleaner promptly.**

Appliance front

If soiling is not removed promptly, it may become impossible to remove, and surfaces can become discolored or change their appearance. Remove soiling immediately.

- Clean the front with a solution of warm water and washing-up liquid applied with a clean sponge or cloth. A clean, damp microfiber cloth without cleaning agent can also be used.
- After cleaning dry the front of the appliance with a soft cloth.

Cleaning and care

PerfectClean

The surfaces of the oven compartment and shelf runners have been treated with **PerfectClean** enamel. This finish has an iridescent appearance. Perfect-Clean surfaces have very good non-stick properties and are easy to clean.

However, it is very important to clean the surfaces each time the oven is used.

The surface will become harder to clean and the non-stick properties will deteriorate if soiling is not removed after each use and allowed to build up.

Soiling such as spilt juices and cake mixtures are best removed while the oven or tray is still warm. Exercise caution, make sure the oven is not hot.

Spilt fruit juices may cause lasting discoloration of the surfaces. This discoloration is permanent but will not affect the efficiency of the surface.

Remove residual cleaning agent after cleaning. If left it will reduce the non-stick properties of the PerfectClean surfaces.

To protect the non-stick effect of PerfectClean surfaces, please avoid:

- Abrasive cleaning agents, such as scouring powder, scouring cream, pumice pits
- Ceramic cooktop cleaners
- Ceramic and stainless steel cleaner
- Steel wool
- Abrasive sponges, e.g. pot scourers or sponges which have been previously used with abrasive cleaning agents
- Oven sprays
- Cleaning in the dishwasher
- Spot cleaners

Do not use oven spray.

Oven interior

The surface of the oven compartment has been treated with Perfect-Clean.

Please refer to the section on "PerfectClean" for information on cleaning and care.

The oven door (see "Door") and the side runners (see "Side runners") can be removed to make it easier to clean the oven interior.

After a program using steam

- Remove:
 - Condensate using a sponge or absorbent cloth
 - Light, greasy soiling with a sponge and a solution of liquid dish soap and hot water
- After cleaning, wipe with clean water to remove any detergent residues.
- Then dry the oven interior and the inside of the door with a cloth.

Tip: You can then leave the oven to dry automatically (see "Cleaning and care - Drying").

After a roasting, grilling or baking program

Clean the oven compartment thoroughly after roasting and baking as otherwise soiling can burn on and become impossible to remove.

- Clean the cooking compartment with a non-scouring washing-up sponge and a solution of dishwashing liquid and hot water. If necessary, the pad on the reverse of the sponge can be used.
- After cleaning, wipe with clean water to remove any detergent residues.
- Then dry the oven interior and the inside of the door with a cloth.

Tip: Soaking the soiling for a few minutes with a solution of dishwashing liquid and hot water can make cleaning easier. Alternatively run the Maintenance Ⓢ | Soak program (see "Cleaning and care - Soak").

Cleaning and care

Drain filter

- The filter in the floor of the oven should be cleaned and dried after every use.
- Vinegar can be used to remove discoloration and limescale deposits from the filter in the floor of the oven. Rinse thoroughly with clean water to remove any residual cleaning agent.

Door gasket

Grease deposits on the seal between the inside of the oven door and the oven interior can cause it to become brittle and cracked.

- Clean the door seal after every baking or roasting program using a clean, damp microfiber cloth or a soft clean sponge and a mild solution of warm water and liquid dish soap.
- After cleaning, dry the seal with a soft cloth.
- Replace the seal with a new one if it becomes porous or brittle.

Door seals can be ordered from the Miele Service (see the end of this booklet for contact details).

Grease filter

Clean the grease filter after every roasting program.

The grease filter can be cleaned in a dishwasher.

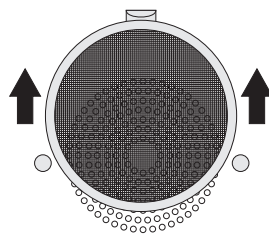

- Pull the grease filter on the back panel upwards to remove it.
- The grease filter can be cleaned in the dishwasher or by hand with a soft clean sponge and a mild solution of warm water and liquid dish soap.

If the grease filter is cleaned in the dishwasher, results are better if the filter is placed horizontally in the basket. Some dishwasher detergents may cause the surface of the filter to discolor. This discoloration will not affect the functioning of the filter in any way.

Water container

The water container is suitable for cleaning in a dishwasher.

- Remove the water container by pushing upwards slightly as you take it out of the appliance. Empty it.

Water can drip into the container compartment when the water container is removed.

- Dry the compartment with a soft cloth.
- Wash the water container by hand using a soft clean sponge and a mild solution of warm water and liquid dish soap or in the dishwasher.
- Dry the water container with a soft cloth to prevent limescale.

Accessories

Cooking pans

The cooking pans are suitable for cleaning in the dishwasher.

- Wash and dry the cooking pans after each use.
- Vinegar can be used to remove bluish discoloration. Rinse thoroughly with clean water to remove any residual cleaning agent.

Universal tray and wire oven rack

The surface of the universal tray and the wire oven rack have been treated with a PerfectClean finish.

Do not clean the universal tray and wire oven rack in the dishwasher.

Please refer to the section on "PerfectClean" for information on cleaning and care.

- Remove:
 - light soiling with a soft clean sponge and a mild solution of warm water and liquid dish soap.
 - heavier soiling with a clean non-scouring sponge and a soft clean sponge and a mild solution of warm water and liquid dish soap. If necessary, the pad on the reverse of the sponge can be used.
- After cleaning, wipe with clean water to remove any detergent residues.
- Dry the surface of the universal tray and the wire oven rack with a soft cloth.

Roast probe

Do not immerse the roast probe in water or clean it in the dishwasher as this will damage it.

- Clean the roast probe with a damp cloth after every use.

Cleaning and care

Shelf runners

The surface of the side runners has been treated with PerfectClean.

Do not clean the side runners in the dishwasher.

Please refer to the section on "PerfectClean" for information on cleaning and care.

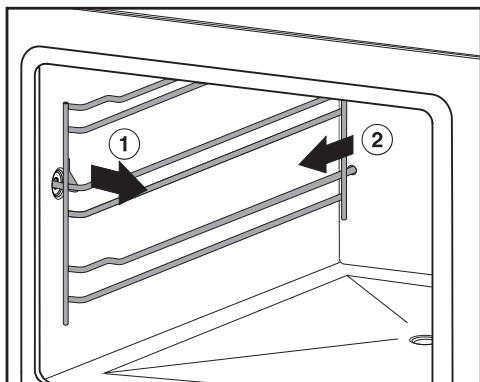

- Pull the side runners out first at the side ①, then at the back ② of the steam oven.

- Remove:
 - light soiling with a clean sponge and a solution of washing-up liquid and hot water.
 - heavier soiling with a clean non-scouring sponge and a soft clean sponge and a mild solution of warm water and liquid dish soap. If necessary, the pad on the reverse of the sponge can be used.
- After cleaning, wipe with clean water to remove any detergent residues.
- Dry the side runners with a soft cloth.
- Push the side runners firmly back in after cleaning. When putting them back in, make sure they are correctly inserted (see illustration).

If the side runners are not correctly inserted there is no anti-tip protection, items could be pulled out of the steam oven inadvertently and the temperature sensor could be damaged when cooking pans are placed in the steam oven.

Maintenance

The Ready at and Start at functions are not available in Maintenance Ⓢ.

Soak

Heavy soiling can be soaked with this program after a roasting program.

- Let the oven compartment cool down.
- Remove all accessories from the oven.
- Select Maintenance Ⓢ | Soak.

The soaking process takes approx. 10 minutes.

Drying

Residual moisture in the oven compartment is dried, even in inaccessible areas.

- Dry the oven cavity with a soft cloth first.
- Select Maintenance Ⓢ | Drying.

The drying process takes approx. 20 minutes.

Rinsing

During this process the water-carrying system is rinsed out. Any remaining food deposits are flushed out of the system.

- Select Maintenance Ⓢ | Rinse.

Rinsing takes approx. 10 minutes.

Descaling

We recommend that you use Miele Descaling Tablets (see "Optional accessories") for descaling the appliance. They have been specifically designed for optimal descaling of Miele products. Other descaling agents, which - in addition to citric acid - may contain other acids and/or other undesirable substances such as chlorides, might damage the product. Also, the desired effect cannot be guaranteed if the descaling solution does not have the required concentration.

Descaling solution is acidic.

Do not spill descaling agent onto metal surfaces. This can cause marks to appear.

However, should any descaling agent get onto these surfaces, wipe it away immediately.

The steam oven needs to be descaled after a certain number of operating hours. When the steam oven needs to be descaled, a number will appear in the display indicating the number of cooking processes remaining before the appliance locks out. Only cooking processes using steam are counted. After the last remaining steam cooking process, the appliance will lock out.

We recommend that you descale the appliance before it locks out.

The water container must be emptied and rinsed during the descaling process.

Cleaning and care

- Switch the steam oven off and select Maintenance  | Descale.

The message *Please wait...* will appear in the display. The descaling process is being primed and may take a few minutes. As soon as the appliance is ready you will be prompted to place descaling agent in the water container.

- Place 2 Miele descaling tablets in the water container.
- Push the water container into the appliance until it engages.
- Confirm with OK.

The descaling process will now begin, and the time left will count down in the display.

It is only possible to cancel the descaling process during the first 6 minutes. Do not switch the appliance off during the descaling process. If it is switched off before the end of the process, the whole process will have to be started again from the beginning.

The water container must be rinsed out, emptied and replaced during the process.

- Follow the instructions in the display.
- Confirm with OK.

Once this has taken place, *Program Finished* will appear in the display.

After descaling

- Remove, empty and dry the water container.
- Switch the steam oven off.
- Let the oven compartment cool down.
- Then dry the oven compartment.
- Leave the appliance door open until the oven compartment is completely dry.

Door

Removal

- Prepare a suitable underlay for the door, such as a soft cloth.
- Open the door slightly.

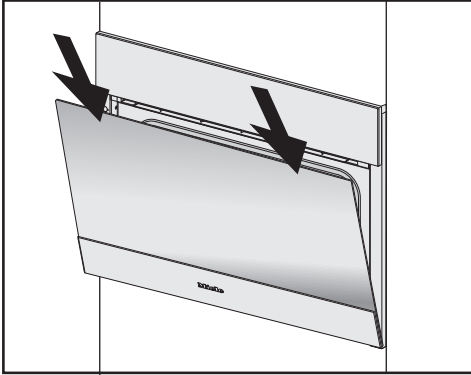

- Using two hands placed on the upper edge of the door, push the door downward briefly.

Before the door can be removed, the locking clamps on both hinges have to be released.

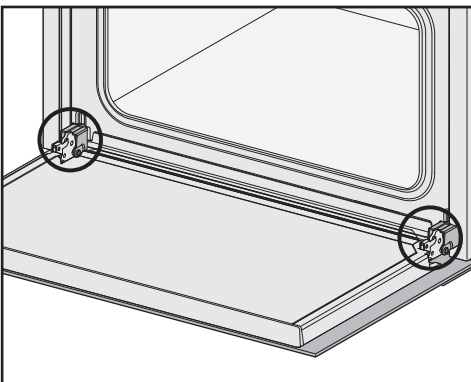

- Open the door fully.

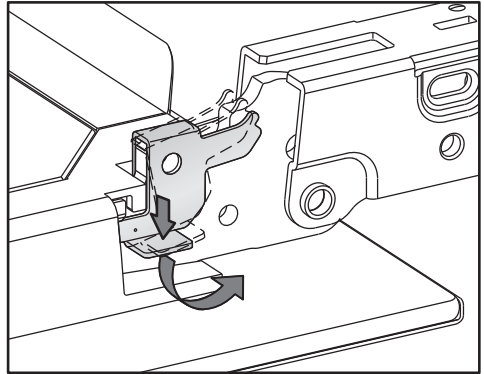

- Release the locking clamps on the hinges by pushing them down. Turn them as far as they will go in an angled position.

⚠ Danger of injury from the hinge guides!

The hinge guides retract to the steam oven.

Never attempt to pull the door off the hinge guides from a horizontal position.

- Close the door until it rests partially open.

Risk of damage to the door!

The door handle could break off and the glass could be damaged.

Do not lift the door by the handle.

Make sure that the door does not tilt during removal.

Cleaning and care

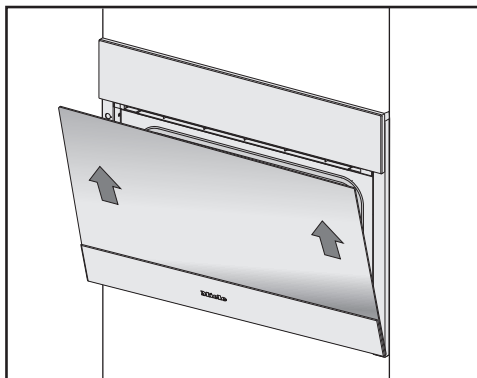

- Hold the door on either side and pull diagonally upwards from the hinge guides.
- Lay the door on the previously prepared underlay.

Refitting

Risk of damage to the door!
Make sure that the door does not tilt when being refitted.

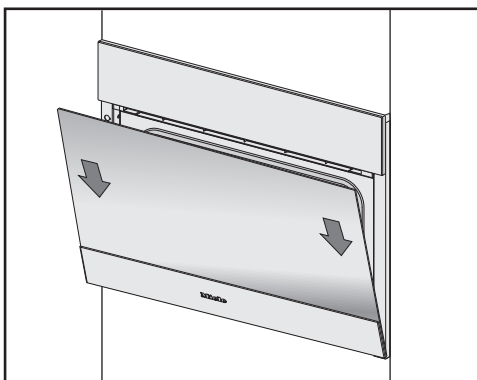

- Slide the door onto the hinge guides again.

Risk of damage to the door!
If the locking clamps are not locked, the door can easily become detached from the hinge guides and be damaged.
You must make sure that the locking clamps are locked again.

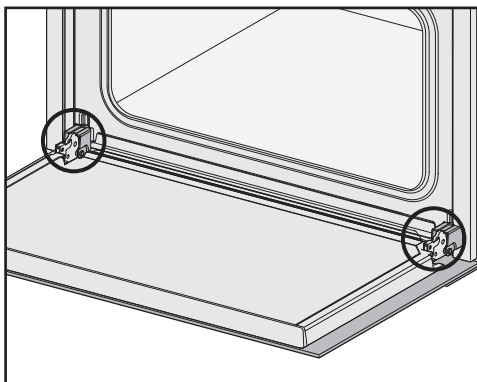

- Open the door fully.

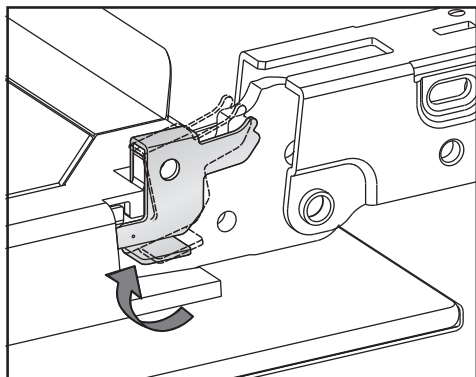

- To relock the locking clamps, turn them back up to the horizontal position as far as they will go.

Frequently asked questions



The following faults can be corrected without contacting the Miele Service Department.

If in doubt, please contact Miele.

 **Risk of injury!** Improperly performed installation, maintenance or repair work can pose a serious danger to users of the appliance.
Installation, maintenance and repairs may only be carried out by Miele authorized technicians.
Do not attempt to open the housing.

Problem	Possible cause and solution
<p>You cannot turn the appliance on.</p>	<p>The circuit breaker has tripped.</p> <ul style="list-style-type: none"> ■ Reset the circuit breaker (see data plate for the correct fuse rating).
	<p>There may be a technical fault.</p> <ul style="list-style-type: none"> ■ Disconnect the appliance from the power supply for approx. 1 minute: <ul style="list-style-type: none"> – tripping the relevant circuit breaker or screwing the fuse out completely, or – tripping the ground fault circuit interrupter (GFCI). ■ If the steam oven still will not turn on, contact a qualified electrician or Miele Service.
<p>The oven does not heat up.</p>	<p>Demo mode is activated. The steam oven can be operated, but the oven heating does not work.</p> <ul style="list-style-type: none"> ■ Deactivate Demo mode (see "Settings – Showroom Program").
	<p>The oven interior has been heated by a heating drawer operating beneath it.</p> <ul style="list-style-type: none"> ■ Open the door and let the oven cool down.
<p>The fan can still be heard after the appliance has been turned off.</p>	<p>The fan is still running. The appliance is fitted with a fan which removes steam from the oven. The fan will continue to run for a while after the appliance has been switched off. It will turn itself off automatically after a while.</p>

Frequently asked questions

Problem	Possible cause and solution
A humming sound can be heard after switching on the appliance, during operation and after turning off the appliance.	This is not a fault. It is made by water being pumped through the system.
After moving house the appliance no longer turns from the heating-up phase to the cooking phase.	<p>The boiling temperature of the water has changed as the altitude of the new location for the appliance differs from the old one by at least 984' / 300 m.</p> <ul style="list-style-type: none"> ■ To adjust the boiling temperature, you need to descale the appliance (see "Cleaning and care - Descaling").
During operation, an unusually large amount of steam escapes or steam escapes from parts of the steam oven where it does not usually.	<p>The door is not properly closed.</p> <ul style="list-style-type: none"> ■ Close the door.
	<p>The door seal is not correctly fitted.</p> <ul style="list-style-type: none"> ■ If necessary, press it in all the way round the door to make sure it is fitted evenly.
	<p>The door seal is damaged, e.g. cracked.</p> <ul style="list-style-type: none"> ■ Replace the door seal. <p>This can be ordered from Miele Service (see the end of this booklet for contact details).</p>
The oven lighting does not come on.	<p>The lamp needs to be replaced.</p> <ul style="list-style-type: none"> ■ Contact Miele Service to have the lamp replaced.
The control panel will not open or close automatically despite tapping the  sensor button several times.	<p>There is an obstruction in the control panel.</p> <ul style="list-style-type: none"> ■ Remove the obstruction.
	<p>The obstruction sensor is very sensitive, which means the control panel sometimes does not open or close.</p> <ul style="list-style-type: none"> ■ Open/close the control panel manually (see end of this section) ■ If the problem occurs again, contact Miele Service.
The <small>Start at</small> and <small>Ready at</small> functions have not worked.	<p>The oven cavity temperature is too high, e.g. after a program has finished.</p> <ul style="list-style-type: none"> ■ Leave the door open to cool down the oven cavity.
	<p>These functions are not generally available with Menu Cooking and Maintenance .</p>

Frequently asked questions

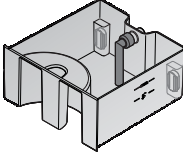
Problem	Possible cause and solution
Cakes and pastry are not cooked properly after following the durations given in the recipe.	The set temperature is not consistent with the one given in the recipe. ■ Change the temperature.
	The grease filter is inserted in the back panel. Baking takes longer with this filter in place. ■ Increase the baking duration.
	The recipe has been altered. For example, adding more liquid or eggs can increase the duration required. ■ Adapt the temperature or baking duration accordingly.
Cakes or pastry are unevenly browned.	The temperature was set too high.
	The grease filter has not been taken out of the back wall.
	More than two shelf levels were used for baking. ■ Bake on a maximum of two levels.
F10	The suction hose in the water container is – is not inserted correctly. – is not positioned vertically. ■ Connect it properly and make sure it is vertical: 
F11 F20	The drain hoses are blocked. ■ Descale the steam oven (see "Cleaning and care - Descaling"). ■ If the fault message appears again, switch the appliance off and contact Miele Service.
F44 F195	Communication fault ■ Turn the steam oven off and then back on again after a few minutes. ■ If the same message appears again, contact Miele Service.

Frequently asked questions

Problem	Possible cause and solution
F 55	<p>The maximum length of time for which the combi steam oven can be operated on a function has been exceeded, so the appliance has switched itself off automatically for safety reasons.</p> <ul style="list-style-type: none">■ Switch the steam oven off and then back on again. <p>The steam oven is immediately ready for use again.</p>
F 94	<p>No water intake:</p> <ul style="list-style-type: none">– the water intake hose is trapped or kinked. <ul style="list-style-type: none">■ Rectify the cause of the problem and start the appliance again.
	<ul style="list-style-type: none">– the water supply has been turned off. <ul style="list-style-type: none">■ Open the water supply stopcock and start the appliance again.
	<ul style="list-style-type: none">– one or both float switches in the water container are stuck. <div data-bbox="631 727 815 884" data-label="Image"></div> <ul style="list-style-type: none">■ Release the float switches or switch so that it moves freely.■ If this fault message appears again after the problem(s) have been corrected, contact Miele Service.
F 190	<p>The water intake valve is faulty.</p> <p>This can occur if the control panel was opened or closed during water intake.</p> <ul style="list-style-type: none">■ Confirm with OK and continue operation.■ If the same message appears again, call Miele Service.

Frequently asked questions

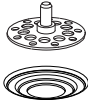
Problem	Possible cause and solution
F 196	<p>There is a fault.</p> <ul style="list-style-type: none">■ Switch the steam oven off and then back on again. <p>The drain filter is not inserted correctly.</p> <ul style="list-style-type: none">■ Turn the steam oven off.■ Insert the filter correctly:  <ul style="list-style-type: none">■ Switch the steam oven back on again.■ If, having corrected the problem, this fault message appears again, contact Miele Service.
F and other fault codes	<p>Technical fault</p> <ul style="list-style-type: none">■ Turn the appliance off and contact Miele.

Frequently asked questions

Opening the control panel manually

- Carefully open the door.

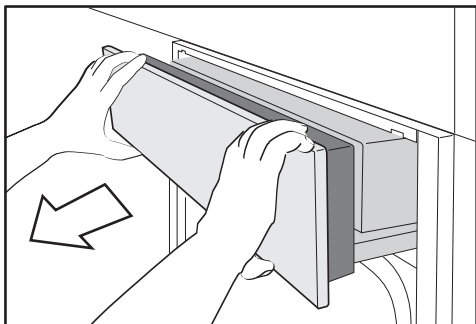

- Hold the control panel at the top and bottom.
- Pull out the panel towards you.
- Carefully push it upwards.

Closing the control panel manually

- Hold the control panel at the top and bottom.
- Carefully push it downwards.

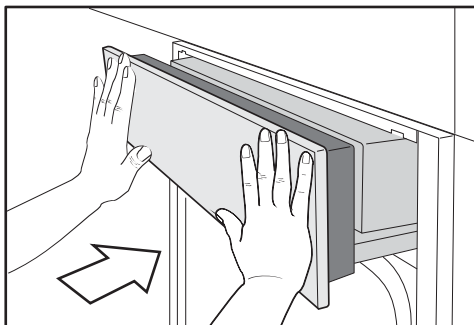

- Push the panel right in.

Miele offers a range of useful accessories, as well as cleaning and conditioning products for your appliance.

These products can be easily ordered from the Miele webstore.

These products can also be ordered from Miele Service (see end of these operating instructions) or your Miele dealer.

Cooking pan

There is a wide range of perforated and solid cooking pans available in different sizes:

Miele offers a number of perforated and solid cooking pans in various sizes. Cooking pans with a width of **12 3/4" (325 mm)** cannot be inserted directly into the shelf runners. Instead they must be placed on the rack.

DGGL 1

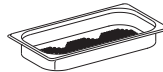

Perforated cooking pan
12 3/4" x 7" x 1 1/2" (WxDxH)
325 x 175 x 40 mm (WxDxH)

DGG 2

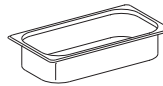

Solid cooking pan
12 3/4" x 7" x 2 1/2" (WxDxH)
325 x 175 x 65 mm (WxDxH)

DGG 3

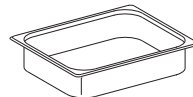

Solid cooking pan
12 3/4" x 10 1/2" x 2 1/2" (WxDxH)
325 x 265 x 65 mm (WxDxH)

Optional accessories

DGGL 4

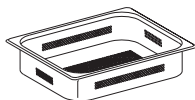

Perforated cooking pan
12 3/4" x 10 1/2" x 2 1/2" (WxDxH)
325 x 265 x 65 mm (WxDxH)

DGGL 5



Perforated cooking pan
12 3/4" x 7" x 2 1/2" (WxDxH)
325 x 175 x 65 mm (WxDxH)

DGGL 6

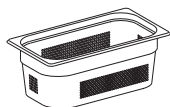

Perforated cooking pan
12 3/4" x 7" x 4" (WxDxH)
325 x 175 x 100 mm (WxDxH)

DGG 7

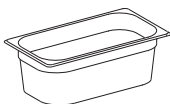

Solid cooking pan
12 3/4" x 7" x 4" (WxDxH)
325 x 175 x 100 mm (WxDxH)

DGGL 8



Perforated cooking pan
12 3/4" x 10 1/2" x 1 1/2" (WxDxH)
325 x 265 x 40 mm (WxDxH)

DGGL 12



Perforated cooking pan
17 11/16" x 15 3/8" x 1 9/16" (WxDxH)
450 x 390 x 40 mm (WxDxH)

DGG 20

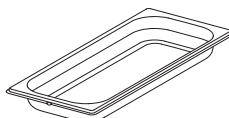

Solid cooking pan
17 11/16" x 7 1/2" x 1 9/16" (WxDxH)
450 x 190 x 40 mm (WxDxH)

DGGL 20

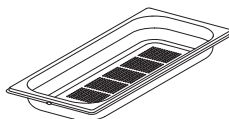

Perforated cooking pan
17 11/16" x 7 1/2" x 1 9/16" (WxDxH)
450 x 190 x 40 mm (WxDxH)

Optional accessories

Lid for cooking pans

DGD 1/3



Lid for 12 3/4" x 7" (325 x 175 mm)
cooking pans

DGD 1/2

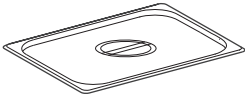

Lid for 12 3/4" x 10 1/2" (325 x 265 mm)
cooking pans

Cleaning and care products

DGCLean (8 oz. / 250 ml)



Special cleaning agent for removing stubborn soiling from the oven interior, particularly after roasting.

Descaling tablets (Qty 6)



For descaling the appliance

Optional accessories

Additional accessories

Universal tray

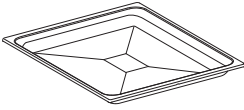

Universal tray for baking, roasting and broiling

Wire oven rack



1 wire oven rack for baking, roasting and broiling

Roast probe

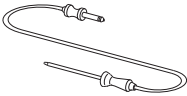

For precise temperature controlled cooking The roast probe monitors the internal temperature of the meat (core temperature).

FlexiClip telescopic runners

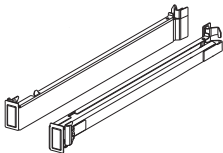

The FlexiClip telescopic runners can be clipped into any of the shelves and pulled out of the oven to their fullest extent.

Rack for cooking pans

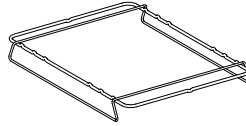

For holding 12 13/16" (325 mm) wide containers. Slides into the side runners in the appliance.

Round baking form

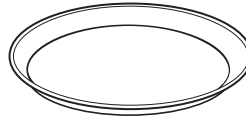

Suitable for cooking pizzas, flat cakes made with yeast or whisked mixtures, sweet and savoury tarts, baked desserts, and can also be used for deep frozen cakes and pizzas.

Not suitable for use with programs using steam

Gourmet casserole dish

Die-cast aluminum casserole dish with non-stick surface. Slides into the side runners in the oven. Also suitable for use on an extended zone of an electric cooktop and in all Miele ovens.

Not suitable for use on gas or induction cooktops.

HUB 5000-XL

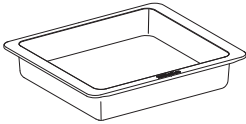

Maximum capacity approx. 16 lbs (8 kg)
Depth 13 3/4" (35 cm)

This oven dish will not fit in the oven with the lid on.

Lid for gourmet casserole dish

Suitable for HUB 5000-M

HBD 60-35

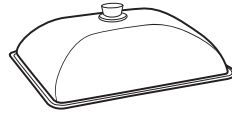

Suitable for HUB 5000-XL

Miele@home

The Miele@home System can only be fitted by an authorized Miele service technician. Please contact Miele for details of this system. It is not available in all countries.

IMPORTANT SAFETY INSTRUCTIONS - INSTALLATION

 Incorrect installation can result in personal injury and damage to property.

- ▶ Before connecting the appliance to the power supply, ensure that the connection data on the data plate (voltage and frequency) match the power supply. This data must correspond in order to avoid the risk of damage to the appliance. Consult a qualified electrician if in any doubt.
- ▶ Do not use an extension cord to connect this appliance to electricity. Extension cords do not guarantee the required safety of the appliance.
- ▶ The electrical outlet should be easily accessible after the appliance has been installed.
- ▶ The appliance must be positioned so that you can see the contents of a cooking pan placed on the top level. Otherwise you may risk scalding or burning yourself with hot water and food when taking containers out of the oven.

▶ Be certain your appliance is properly installed and grounded by a qualified technician. To guarantee the electrical safety of this appliance, continuity must exist between the appliance and an effective grounding system. It is imperative that this basic safety requirement be met. If there is any doubt, have the electrical system of the house checked by a qualified electrician.

All dimensions in this instruction booklet are given in mm and inches.

Note to the installer:

Please leave these instructions with the consumer of the appliance for the local building inspectors use.

Detailed dimensions of oven front

PureLine front

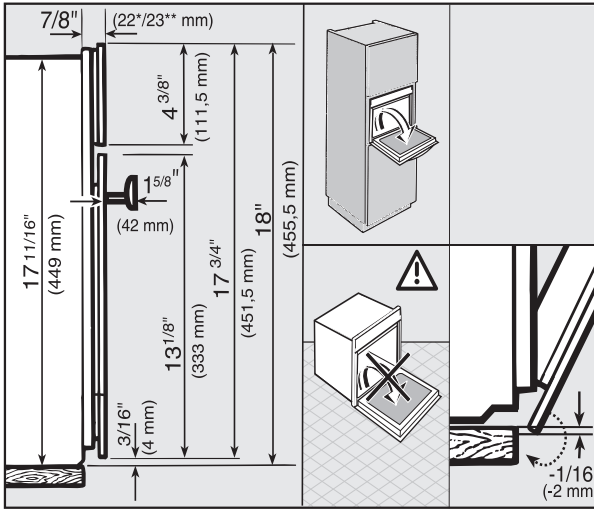

ContourLine front

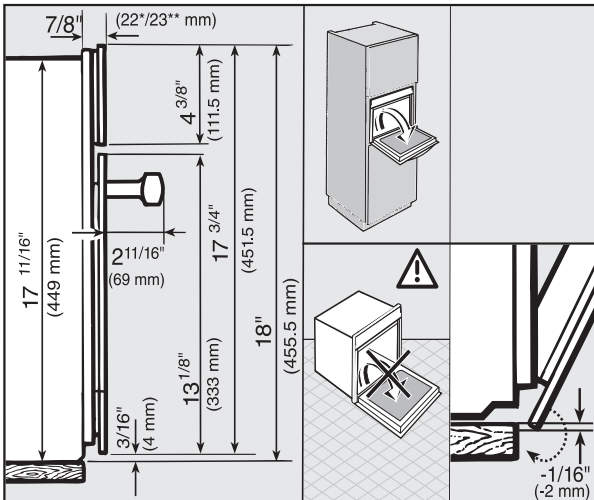

* Glass front / ** Metal front

Detailed dimensions of oven front

Control panel swivel range

The area in front of the control panel must not be blocked by anything (such as a door handle) that would hinder it from opening and closing.

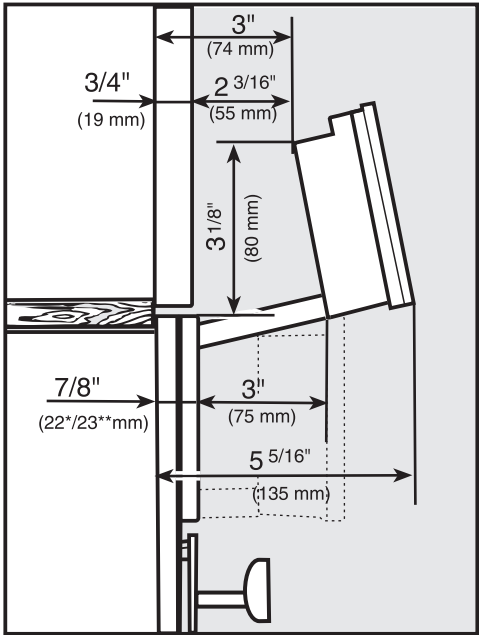

* Glass front / ** Metal front

Connecting the water intake and drain hoses

Incorrectly laid water hoses can damage the steam oven.

Important: If the appliance is installed in conjunction with an oven, ensure that the water intake and drain hoses are not trapped behind its opening.

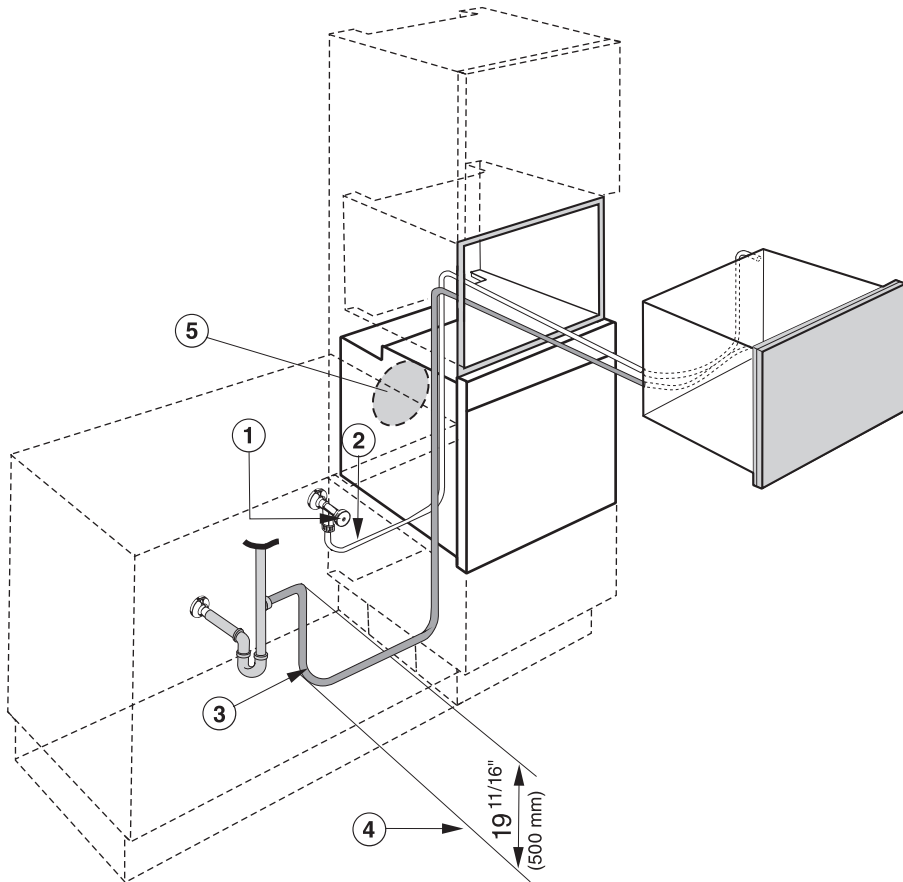

- ① Water supply valve (cold water connection)
- ② Water intake hose, L = 78 3/4" (2,000 mm)
- ③ Drain hose, L = 9' 10 1/8" (3,000 mm)
- ④ The top end of the drain hose to the inlet of the odor trap must not be higher than 19 11/16" (500 mm).
- ⑤ Air intake grilles

Installation dimensions

Installation into a tall cabinet

The housing unit must not have a back panel installed behind the building-in niche.

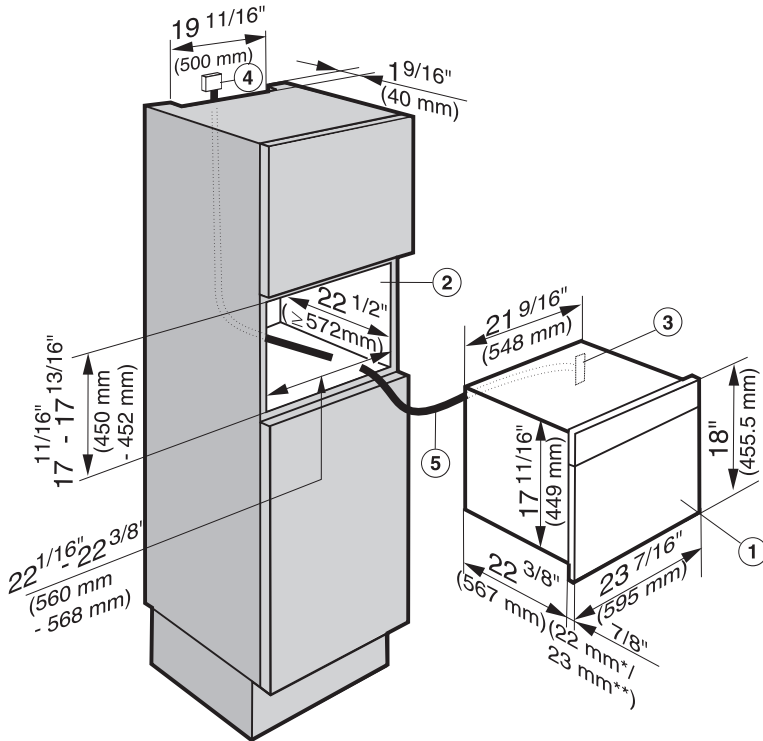

- ① Steam oven
- ② Niche
- ③ Pass-through for the power cord
- ④ Recommended position for electrical connection
- ⑤ Power cord

* Glass front / ** Metal front

Cut-outs for ventilation and plumbing hoses

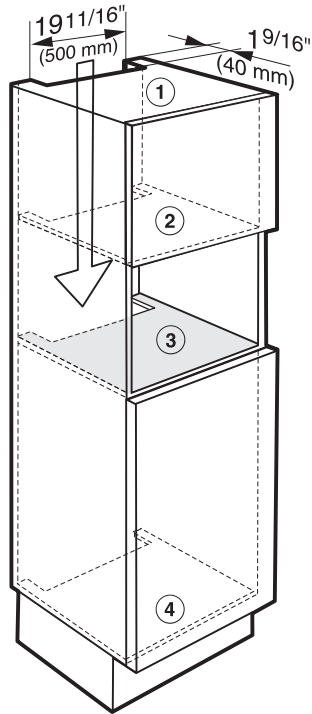

- ① Cut-out in top of unit (for ventilation)
- ② Cut-out in the interim shelf above the installation niche (for ventilation)
- ③ Cut-out in the interim shelf below the installation niche (for plumbing)
- ④ Cut-out in unit floor (for plumbing)

Installation dimensions

Undercounter installation

The housing unit must not have a panel installed at the back of the installation niche.

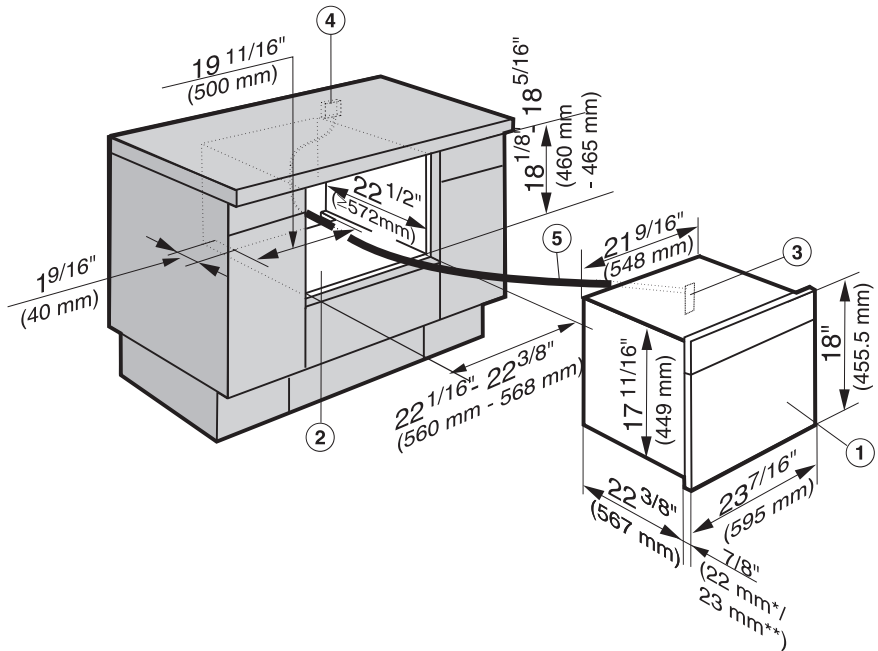

- ① Steam oven
- ② Niche
- ③ Inlet for the power cable
- ④ Recommended position for electrical outlet
- ⑤ Power cable

* Glass front / ** Metal front

Cut-outs for ventilation and plumbing hoses

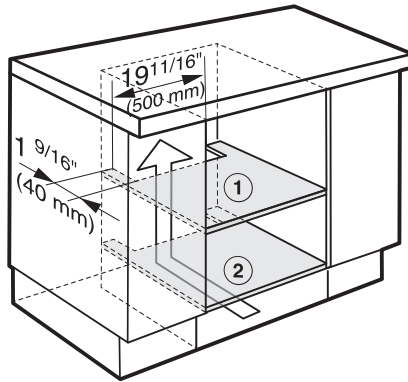

- ① Cut-out in the center shelf under the building-in niche
- ② Cut-out in cabinet base

Installation dimensions

Installation in combination with an oven

The housing unit must not have a back panel installed behind the building-in niche.

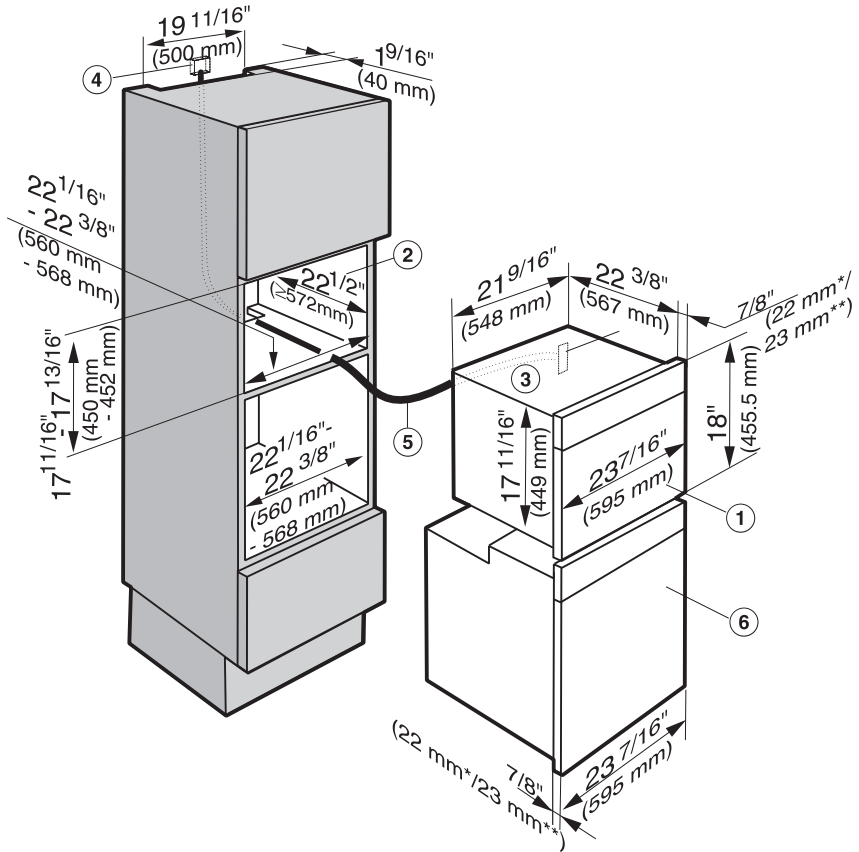

- ① Steam oven
- ② Niche
- ③ Pass-through for the power cord
- ④ Recommended position for electrical connection
- ⑤ Power cord
- ⑥ Oven

* Glass front / ** Metal front

Cut-outs for ventilation and plumbing hoses

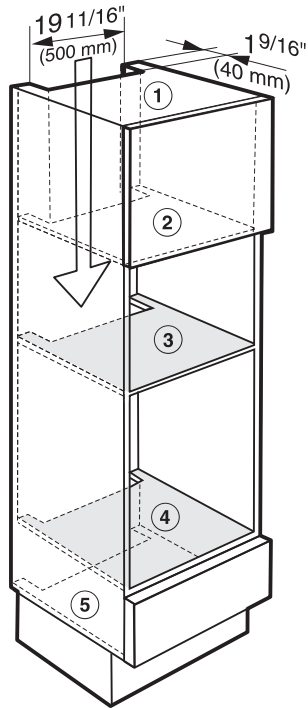

- ① Cut-out in top of unit (for ventilation)
- ② Cut-out in the interim shelf above the installation niche (for ventilation)
- ③ Cut-out in the interim shelf below the installation niche of the steam oven (for plumbing)
- ④ Cut-out in the interim shelf below the installation niche of the oven (for plumbing)
- ⑤ Cut-out in unit floor (for plumbing)

For the oven ventilation cut-out, please see the information in the oven installation instructions.

Installation and connection

Preparing the steam oven

Before installing and connecting the appliance to services, please read "Water connection."

Securing the water intake hose

The water intake hose is connected to the back of the appliance, top left hand side.

- Connect the end of the stainless steel hose to the intake connection. Make sure it is screwed on correctly and securely.

Securing the drain hose

The drain hose is connected to the back of the appliance, bottom left hand side.

- Connect the end of the plastic hose to the appliance and secure it with the hose clip.

Install and connect the appliance

A fault can occur if the appliance is not correctly aligned.

For correct functioning of the steam generator please make sure that the appliance is horizontally level. The maximum deviation should not exceed 2°.

- Connect the power cord to the appliance.
- Feed the water intake hose and the drain hose through the cut-out in the base of the housing unit.

- Push the appliance into the niche and align it. Make sure that the power cord and water intake and drain hoses do not get trapped or damaged when doing so.

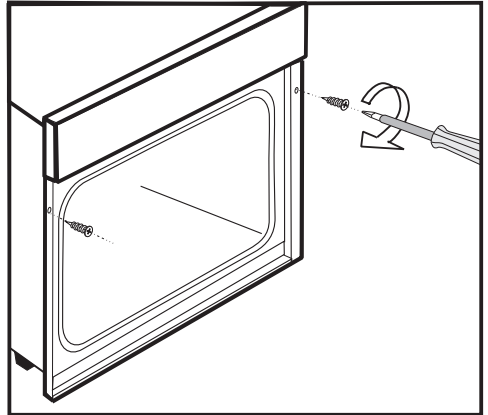

- Secure the appliance left and right using the screws supplied 1/8" x 1" (3.5 mm x 25 mm) to the sides of the unit, as illustrated.
- Connect the appliance to the water supply and the drainage point (see "Connection to the water supply and drainage system").
- Connect the appliance to the electrical supply.
- Check the appliance for correct function in accordance with the Operating Instructions.

The water intake and drain hoses must be laid in such a way that the appliance can be pulled out of its niche for service work.

- Before connection, check the intake and drain hoses for visible signs of damage.

Water intake and drain hoses

- Braided stainless steel supply hose
Length 9' 10" (3 m)
Connection to water supply
3/8" Compression fitting
- Drain hose
Length 9' 10" (3 m)
Connection to trap
3/4" (19 mm) flexible coupling

When routing the water lines through piping, we recommend an internal duct diameter of at least 2" (50 mm).

Connection to the water supply

 **WARNING** - Read all instructions before installation or use of the steam oven to prevent injury and machine damage.

Connection to the water supply should only be carried out by a qualified and competent person in strict accordance with national and local safety regulations.

If connected to a domestic water softening unit, please make sure that the conductivity level of the water is maintained.

All items used for connecting the appliance to the water supply must comply with the current national and local safety regulations in the country in which the appliance is being installed.

The appliance must be connected to the **cold water** supply only.

The water intake pressure must be at least 14.5 psi / 100 kPa (1 bar) and not exceed 87 psi / 600 kPa (6 bar). If it is higher than 87 psi / 600 kPa (6 bar), a pressure reducing valve must be fitted.

The stainless steel intake hose supplied must not be shortened, extended or replaced by a longer hose. Only the new hose sets supplied with the appliance are to be used. Old or previously used hoses must not be connected to the appliance.

Before connecting the appliance to the electrical supply and after any work on it, please flush the pipework through to remove any deposits.

Water connection

- A non-return valve is not required.
- The water quality must conform to the requirements for drinking water in the country in which the appliance is being installed.
- The water intake hose must be connected to the drinking water supply by a faucet with a $\frac{3}{4}$ " threaded union. If this is not present, one must be installed by a suitably qualified plumber.
- The faucet must be easily accessible after the appliance has been installed.
- Only genuine original Miele hoses can be used with this appliance.

Connecting the water supply



Danger of electrical shock!
Plumbing connections cannot be made while the appliance is connected to the electrical supply.

- Disconnect the appliance from the electrical supply.
- Connect the stainless steel intake hose to the water supply.
Ensure that the hose is installed correctly and that it is watertight.

The connection point is subject to water pressure. Turn on the faucet slowly and check for leaks. Correct the position of the washer and union if appropriate.

Connection to the drainage system

 **WARNING** - Read all instructions before installation or use of the steam oven to prevent injury and machine damage.

The drainage trap must not be located higher than the drain hose connection point on the appliance. This is to ensure that water can drain out completely after a program. The top end of the drain hose must not be higher than 19 11/16" (500 mm) where it connects to the siphon. The plastic drain hose supplied must not be shortened.

The drain can be connected to either

- a surface mounted or flush-mounted siphon with a fixed hose connection or
- to the appliance's rinsing siphon connection.

The temperature of the drainage water is approx. 160°F / 70°C.

Only genuine original Miele hoses can be used with this appliance.

Connecting the drain hose

- Connect the plastic hose to the siphon using the hose sleeve \varnothing 3/4" (21 mm).
- Then secure the hose with the hose clamp.

Electrical connection

ATTENTION:

Before installation or servicing, disconnect the power supply by either removing the fuse, manually "tripping" the circuit breaker or unplugging the appliance. Pull the plug not the cord.

Installation work and repairs should only be performed by a qualified technician in accordance with all applicable codes and standards. Repairs and service by unqualified persons could be dangerous and the manufacturer will not be held responsible. Installation, repair, and maintenance work should only be performed by a Miele-authorized service technician. Work by unqualified persons can cause considerable danger to users. Miele cannot be held liable for any damage arising as a result of such work.

Before connecting the appliance to the power supply, make sure that the voltage and frequency listed on the rating label correspond with the household electrical supply. This data must correspond to prevent appliance damage. Consult an electrician if in doubt.

For safety reasons, the steam oven may only be used when it has been fully installed.

Installer:

- Please leave these instructions with the customer.

Connection

- Ensure that the connection data on the data plate (voltage, frequency, and fuse rating) match those of your electrical supply.

Power Supply

This appliance is equipped with a 5 ft (1.5 m) long power cord with a NEMA 6-20P three-prong grounding plug ready for connection.

208/240 V / 20 A / 60 Hz

Make sure that the connecting socket is accessible after the installation of the steam oven.

Replacing the power cord

Danger of electrical shock!

The power cord must only be replaced by a suitably qualified and competent person in accordance with current local and national safety regulations in order to avoid a hazard.

If the power cord needs to be replaced, it must be replaced with a special connection cable, type H 05 VV-F (PVC insulated), available from Miele.

Disposal of the packing material

The cardboard box and packing materials protect the appliance during shipping. They have been designed to be biodegradable and recyclable.

Ensure that any plastic wrappings, bags, etc. are disposed of safely and kept out of the reach of children. Danger of suffocation!

Disposal of your old appliance

Electrical and electronic appliances contain valuable materials. They also contain certain substances, compounds and components which were essential for the proper functioning and safe use of the equipment. Handling these materials improperly by disposing of them in your household waste can be harmful to your health and the environment. Therefore, please do not dispose of your old appliance with regular household waste and follow local regulations on proper disposal.



Consult with local authorities, dealers or Miele in order to dispose of and recycle electrical and electronic appliances. Miele assumes no responsibility for deleting any personal data left on the appliance being disposed. Please ensure that your old appliance is kept away from children until removal. Observe safety requirements for appliances that may tip over or pose an entrapment hazard.

Technical service, data plate, warranty

After sales service

In the event of a fault which you cannot easily correct yourself, please contact:

- your Miele dealer, or
- the Miele Technical Service Department.

See back cover for contact details.

Please quote the model and serial number of your appliance when contacting Miele.

Data plate

Adhere the extra data plate supplied with the appliance here. Ensure that the model number is the same as the one on the back of these operating instructions.

Warranty

For further information, please refer to your warranty booklet.

This service is available in USA only.

MieleCare, our Extended Service Contract program, gives you the assurance of knowing that your appliance investment is covered by 5 years of worry free ownership.

MieleCare is the only Extended Service Contract in the industry that guarantees repairs by a Miele Authorized Service Provider using genuine Miele parts. Only genuine Miele parts installed by factory trained professionals can guarantee the safety, reliability, and longevity of your Miele appliance.

Please note that unless expressly approved in writing by Miele's Service department, Extended Service Contracts offered by other providers for Miele products will not be recognized by Miele. Our goal is to prevent unauthorized (and untrained) service personnel from working on your Miele products, possibly doing further damage to them, you and/or your home.

To learn more about **MieleCare** Extended Service Contracts, please contact your appliance dealer or visit us online at:

www.mieleusa.com

Copyright and licenses

Miele uses software to operate and control the appliance.

The copyright authorization from Miele and other relevant software suppliers (e.g. Adobe) must be respected.

Miele and their suppliers reserve the rights to the software components.

In particular the following are prohibited:

- copying and distribution,
- modifications and derivations,
- decompilation, reverse engineering, disassembling and other such reductions of software.

This product contains Adobe® Flash® Player Software under licence from Adobe Systems Incorporated, Adobe Macromedia Software LLC. Adobe and Flash are registered trademarks of Adobe Systems Incorporated.

Components which fall under GNU General Public Licence and further Open Source licenses are integrated into the software.

An overview of the integrated Open Source components and a copy of the current licence can be obtained at <http://www.miele.com/device-software-licenses>. You will need to enter the specific product name.

Miele will provide the source code for all components of software licensed under the GNU General Public License and comparable Open Source licenses.

For source code requests, please email info@miele.com.

Please have the model and serial number of your appliance available when contacting Technical Service.

The Miele logo consists of the word "Miele" in a bold, white, serif font, set against a solid black rectangular background.

U.S.A.

Miele, Inc.

National Headquarters

9 Independence Way
Princeton, NJ 08540
Phone: 800-843-7231
Fax: 609-419-4298
www.mieleusa.com

Technical Service & Support

Phone: 800-999-1360
Fax: 888-586-8056
TechnicalService@mieleusa.com

International Headquarters

Miele & Cie. KG
Carl-Miele-Straße 29
33332 Gütersloh
Germany

Canada

Importer
Miele Limited

Headquarters and Miele Centre

161 Four Valley Drive
Vaughan, ON L4K 4V8
www.miele.ca

Customer Care Centre

Phone: 800-565-6435
905-532-2272
customercare@miele.ca

DGC 6705-1 / DGC 6805-1



en-US, CA

M.-Nr. 10 357 820 / 02